

# GP-200LT

## MULTI-EFFECTS PROCESSOR

### User Manual

For Firmware V1.3.0



# VALETON

※ In the interest of product improvement, the specifications and/or the content of products (including but not limited to appearances, packaging design, manual content, accessories, size, parameters and display screen), are subject to change without prior notice. Please check with local supplier for exact offers. Specifications and features (including but not limited to appearances, colors and size) may vary by model owing to environmental factors, and all images are illustrative.

# Contents

<b>Welcome</b> .....	1	With guitar amps (using FX Loop to pre-position the GP-200LT).....	20
<b>Attention</b> .....	1	With guitar amps (using FX Loop to post-position the GP-200LT).....	20
<b>Overview</b> .....	2	With guitar amps (using FX Loop to run the 4 cable method).....	21
<b>Panel Introduction</b> .....	3	With other pedals.....	21
<b>Getting Started</b> .....	4	Audio Studio (for livestreaming).....	22
<b>Screen Introduction</b> .....	5	<b>EFFECT LIST</b> .....	23
Main Display Screen.....	5	PRE.....	23
TUNER.....	5	WAH.....	26
LOOPER.....	6	DST.....	26
DRUM.....	6	AMP.....	30
MIDI Device Control Functions (MIDI).....	7	NR.....	39
EXP Pedal.....	7	CAB.....	40
<b>Patch Setting</b> .....	8	EQ.....	42
Edit Menu.....	8	MOD.....	42
Editing a Module.....	8	DLY.....	44
Managing the Signal Chain.....	8	RVB.....	46
Patch Settings.....	9	VOL.....	47
Save Menu.....	10	<b>Drum Rhythm List</b> .....	48
<b>Global Settings</b> .....	10	<b>MIDI Control Information List</b> .....	51
Input/Output.....	11	<b>Troubleshooting</b> .....	53
USB Audio.....	11	<b>Technical Specifications</b> .....	54
Footswitch.....	12		
EXP Calibrate.....	13		
EXP 2/Footswitch.....	14		
MIDI.....	14		
Display.....	15		
Auto CAB Match.....	15		
Global Eq.....	16		
About.....	17		
Factory Reset.....	17		
<b>Compatible software</b> .....	18		
<b>Application Scenarios</b> .....	19		
With full-range speaker devices.....	19		
With guitar amps (INPUT jack).....	19		

## Welcome

- Thank you for purchasing a VALETON product.
- We know it might be tedious but please read this manual carefully to get the most out of your GP-200LT.
- Please keep this manual for future reference.

## Attention

### Handling

- Do not get the unit wet. If liquid is spilled on the unit, shut it off immediately.
- Do not block any jack of the unit.
- Keep away from heat sources.
- Disconnect the unit during storms to prevent damage.
- Operation of this unit within significant electromagnetic fields should be avoided.

### Connecting the power and input/output jacks

- Always turn OFF the power to the unit and all other equipment before connecting or disconnecting any cables. Also make sure to disconnect all connection cables and the AC adapter before moving the unit.

### Cleaning

- Clean only with a dry cloth.

### Alterations

- Do not open the unit.
- Do not attempt to service the unit yourself.
- Operation of this unit within significant electromagnetic fields should be avoided.

### AC Adapter Operation

- Always use a DC9V center negative 1000mA AC adapter. Use of an adapter other than that specified could damage the unit or cause malfunction and pose a safety hazard. Always connect the AC adapter to an AC outlet that supplies the rated voltage required by the adapter.
- Unplug the unit during lightning storms or when unused for long periods of time.

### Malfunction

- If the unit malfunctioned, disconnect the AC adapter and turn the power OFF immediately. Then, disconnect all other connected cables.
- Prepare information including the model name, serial number, specific symptoms related to the malfunction, your name, address and telephone number and contact the store where you bought the unit, or contact VALETON support([service@valeton.net](mailto:service@valeton.net))

**Thank you for choosing a VALETON product!**

## Overview

Based on GP-200's technology, Valeton now delivers this predecessor's Lite version -- GP-200LT. With 4 footswitches, enormous I/O options, large color-display screen and user-friendly buttons and knobs, as well as 11 freely movable effect modules and more than 240 patches from world-renowned classic speakers, IRs and effect units, GP-200LT will fit into any scenario to become your go-to gear.

GP-200LT also offers 180-second looper, 100 high-quality drum patterns and the editor software of Windows/Mac, or directly plays as an audio interface compatible with multiple platforms (Windows/Mac/iOS/Android), escorting immeasurable convenience to your songwriting, practice and recording. The pedalboard- friendly compact size will not yield to creativities for its capability of FX loop, external footswitches and MIDI. GP-200LT, the suited partner on and off the stage.



# Panel Introduction

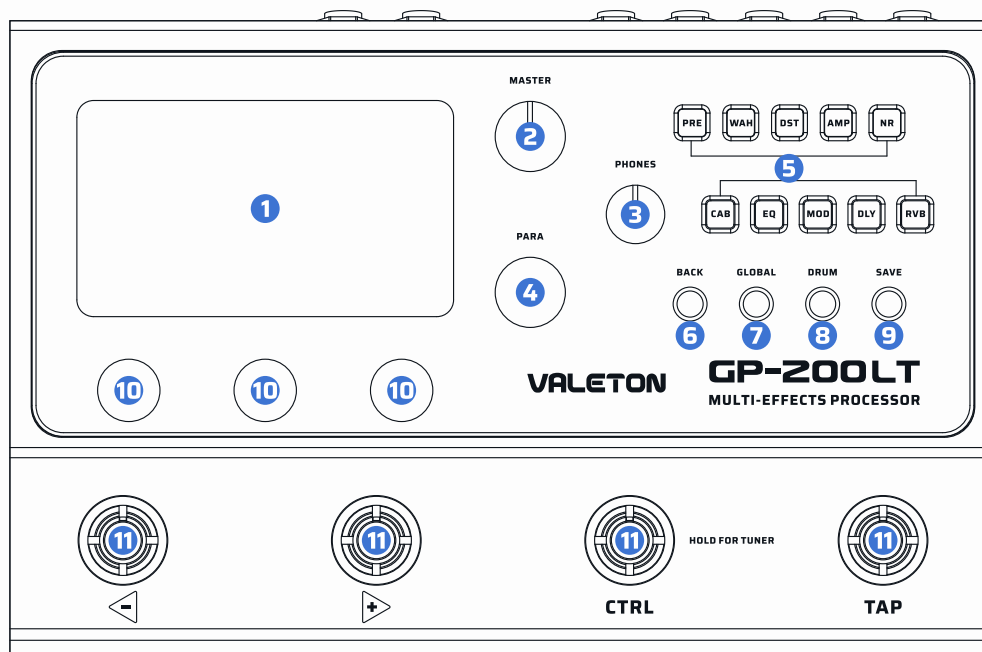

## 1. LCD Display

4.3" colour LCD shows GP-200LT's patch numbers, patch names, and other operation information.

## 2. MASTER Knob

Turn to control GP-200LT's 1/4" jacks output volume.

## 3. PHONES Knob

Turn to control headphones output volume.

## 4. PARA Knob (with enter button)

Turn to select menus and adjust parameters.

## 5. Module Buttons

Press to enter the Edit Settings menu of module, hold for module on/off.

## 6. BACK Button

Press to return to the previous, hold to return to the main display screen.

## 7. GLOBAL Button

Press to enter the Global Setting menu, where you can edit the global parameters of the GP-200LT.

## 8. DRUM Button

Press to play the drum. Hold to enter the Drum Machine Edit menu, where you can edit the drum parameters (style, BPM, volume).

## 9. SAVE Button

Whenever a patch is modified, the main display will show a symbol to indicate that the parameter has been changed. Use SAVE button to store, rename, or copy the patch. Press SAVE button again to store the changed parameter.

## 10. Quick Access Knobs

Turn to adjust parameters on the lower part of the screen. Each knob will vary in function according to the parameter on the display.

## 11. 4 Footswitches

Use to change patches, turn on/off effects, set tap tempo, bypass device, etc.

## Panel Introduction

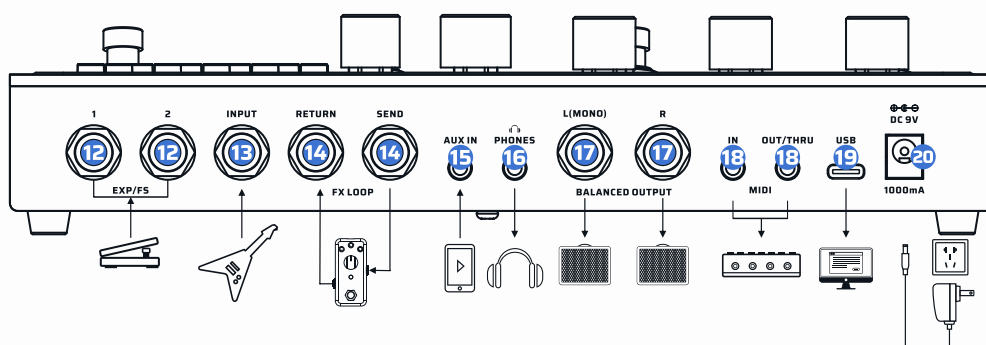

### 12. EXP/FS Jacks

A pair of 1/4" TRS inputs, for connecting an external expression pedal/footswitch controller.

### 13. INPUT Jack

1/4" TS input connection for guitar or other instruments.

### 14. FX LOOP(SEND/RETURN) Jack

These 1/4" TS jacks can be used as FX loop for inserting external stompboxes into your tone. SEND/RETURN node is after AMP module, and is moved with AMP module.

### 15. AUX IN Jack

1/8" TRS input for connecting an audio player and playing along (or recording).

### 16. PHONES Jack

1/8" TRS output for connecting headphones.

### 17. BALANCED OUTPUT

Use 1/4" TS cables for unbalanced output to connect to your guitar amp, FRFR speakers or other playback system. You can also use 1/4" TRS cables for balanced output to connect to your studio gear, mixer or PA system. For mono output, use only the L (MONO) jack.

### 18. MIDI Jacks

1/8" TRS jacks for connecting external MIDI devices.

### 19. USB Jack

By connecting USB 2.0 Type-C to Mac and Windows computers, GP-200LT also functions as a high quality audio interface with DI, Re-amping and MIDI functionality built right in.

### 20. DC 9V Jack

Power Requirements: DC 9V, 1000mA,  $\oplus$   $\ominus$   $\ominus$

## Getting Started

1. Connect your device. Plug your guitar into the GP-200LT's INPUT jack, and run a cable from the BALANCED OUTPUT L (MONO) to your amp.

Please remember:

- For your hearing health, and device safety, the volume of GP-200LT and amp is suggested to keep down before power on. Then adjust the volume to a suitable level per demand.
- Connect your cable to the amp's FX Loop Return if it has one.

2. Connect the power supply to turn on GP-200LT.

3. Tune your strings. Hold footswitch CTRL (HOLD FOR TUNER) to activate the tuner mode. Pluck each string and tune it until the pitch reaches the middle of the screen and turns green. When all strings are tuned, tap either of the footswitches again to exit the tuner.

## Getting Started

### Select a patch

GP-200LT includes 256 patches, with the first 100 (01-A-25-D) containing default factory parameters. When performing a factory reset, you can separately reset these 100 patches to the default values.

Tap footswitch <math>\triangleleft</math>, <math>\triangle></math>, to choose a patch you like. Tap footswitches <math>\triangleleft</math> and <math>\triangle></math> together to enter BANK selection menu.

## Screen Introduction

### Main Display Screen

Main Display Screen is the home page displayed right after the power is turned on. You can directly see the key information and settings of the current patch.



- A. Patch number
- B. Patch name
- C. Patch volume monitor
- D. Patch BPM
- E. Patch volume
- F. EXP pedal state
- G. Patch state
- H. DRUM state
- I. Current footswitch setting
- J. Quick adjust paras

### TUNER

Hold the [CTRL] footswitch to activate the tuner mode.

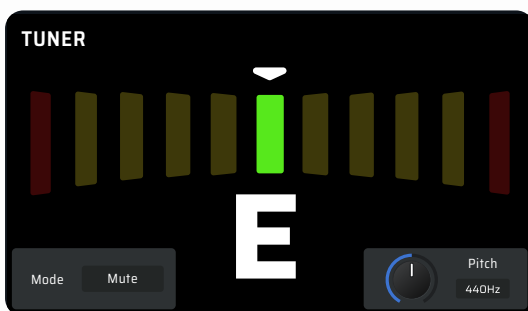

In tuner mode, the LED screen will display the tuning interface. When you pluck a string, the note will appear in the center. Left of center is flat, and right of center is sharp. As you tune your instrument towards the middle, the color of the scale will change from red (out of tune) to yellow (near pitch) to green (in tune).

- Turn Quick Access Knob 1 to select the work mode of the tuner:
  - Thru: Your tune will be normal.
  - Bypass: Effect chain will be bypassed, and you will only hear the dry guitar input sound.
  - Mute: There will be no output.
- Turn Quick Access Knob 3 to change the standard A's frequency ranged from 432Hz to 447Hz, with default set to 440Hz.
- Tap any footswitch to return back to the Main Display Screen.

## Screen Introduction

### LOOPER

In the Main Display screen, tap [+] and [CTRL] footswitches together to enter Looper.

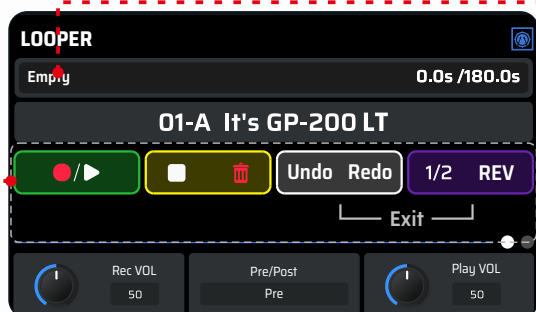

Recording-red      Playing-green      Overdubbing-blue

Turning PARA knob on this page to switch current patch, clicking PARA knob to access more options. When double options are provided in the footswitch function display, the left corresponds to tap and the right corresponds to hold.

- Rec VOL: Change the recording volume of the looper;
- Pre/Post: Change the position of the looper in the effects chain, when setting to “Post”, the recording time will be cut to half.
- Play VOL: Change the volume of the looper when playing back;
- Recording Time: When “Undo/Redo” are not required, you can select up to 180s recording time.
- Sync\*: Synchronize the drumbeat to the timeline of the looper. When activating the looper and playing the drum, the audio will adjust in a brief period of time to match with the drumbeat.
- Auto Rec: Turn on/off the auto-recording, when activating auto-recording, the GP-200LT will not immediately start to record until certain level of input signal is perceived.

Footswitches function differently in the LOOPER interface than in the Home Screen, and their default functions are set below:

Footswitch		FS 1 [-]	FS 2 [+]	FS 3 [CTRL]	FS 4 [TAP]
Function	Tap	Record/Playback	Stop	Undo	1/2 Speed
	Hold		Clear	Redo	Reverse

Note:

Sync requires the margin of error to be under 50ms, otherwise the sync would not function normally.

### DRUM

Press the “DRUM” button to turn on the drum, hold it to enter the DRUM menu.

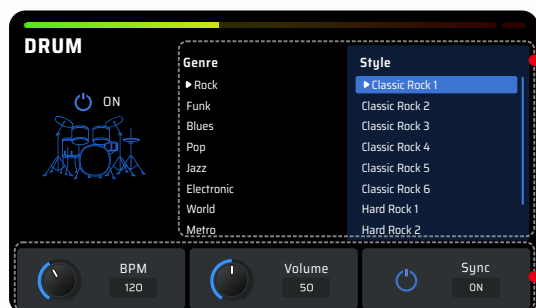

Turn PARA to switch genres, click PARA to switch Genre and Style.

GP-200LT includes 100 drum patterns (check the Drum Patterns list for details)

- Turn Quick Access Knob 1 to change the tempo of the drum, ranged from 40-250 BPM.
- Turn Quick Access Knob 2 to change the volume of the drum, ranged from 0-100;
- Turn Quick Access Knob 3 to synchronize the drum tempo with the patch tempo.
- Click “Back” button to exit Drum menu.



After the drum is turned on, a symbol will be displayed on the right side of the main interface to show the drum machine is active.

## Screen Introduction

### MIDI Device Control Functions (MIDI)

In a default footswitch setting, you can enter the MIDI control interface by pressing the footswitch 3+4 simultaneously.

This interface can control the external MIDI devices and adjust the settings of the plugins when using the MIDI learn function in the DAW.

All 4 MIDI switches and 1 MIDI pedal are ready to use in this interface.

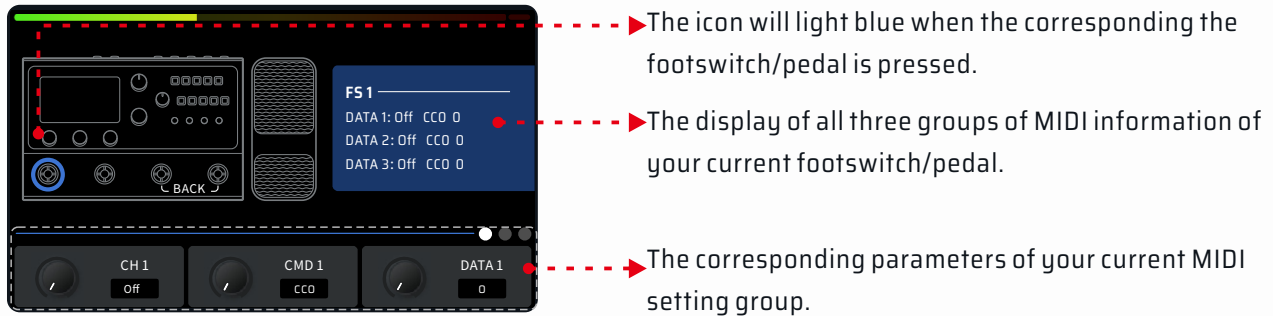

Each footswitch can have three groups of MIDI information.

CH 1/2/3: default is off, adjustable from 1-16

CMD 1/2/3: range from CCO~CC127~PC. (CC: Control Change)/(PC: Program Change)

DATA 1/2/3: adjust the parameter of CC/PC in CMD 1/2/3

GP-200LT supports two types of MIDI messages (CC/PC), the parameters in DATA 1/2/3 will vary based on the type of MIDI function you intend to use.

#### Note:

Only in this interface for using GP-200LT to control external MIDI devices.

### EXP Pedal

The icon will show up on the Main Display Screen at the top left to indicate the expression pedals' working status:

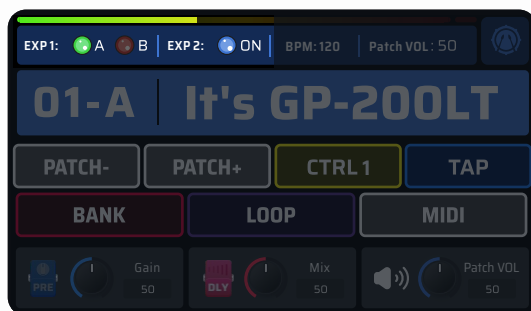

The GP-200LT supports the use of two external expression pedals at the same time. You can use the external expression pedal to control various parameters in real time.

It is recommended to calibrate the pedal(s) when you use an external pedal for the first time or change the brand/model of the expression pedal. Please refer to "Global Settings - EXP Calibrate".

When connect an expression pedal with EXP 1, it can provide two states of A/B. You can use the built-in footswitches or external footswitch 3/4 to set the function to set the function of switching the A/B state of EXP 1. For details, please refer to "GLOBAL SETTINGS - Footswitch" or "GLOBAL SETTINGS - EXP/Footswitch".

Some GP-200LT patches have already been set up to use the EXP 1, without any further set up;

Refer to the expression pedal setting section to customize the expression pedal settings.

# Patch Setting

## Edit Menu

Click PARA to enter Edit Menu.

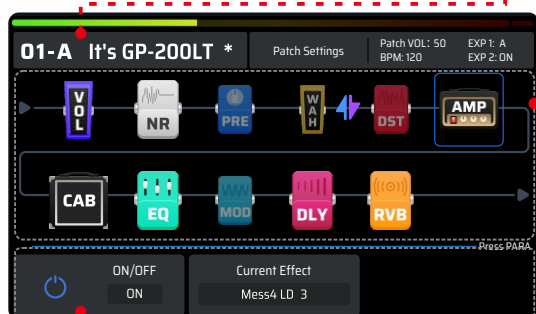

Showing the current patch number and name

The complete signal chain simulation of the GP-200LT. You can directly view all 11 modules' sequence and on/off status based on the color of the icons. Shaded dark indicates off and exposed bright indicates on.

The default sequence of the signal chain is: PRE - WAH - DST - AMP - NR - CAB - EQ - MOD - DLY - RVB - VOL. You can freely move and adjust the effects sequence to create your own ideal tones.

In Quick Access display area, you can check the currently loaded effect's status.

### Note:

Please remember to save after editing your parameters.

A "\*" sign with patch name indicates that the parameters of current patch is changed. If without saving, the change will be removed by changing the patch.

## Editing a Module

Choose a module in the Edit Menu using PARA knob and click it to see all effects listed in this module.



All effects in the module are listed on the right of the screen, turn PARA knob and click to switch effects.

Click PARA knob to access more options.

For specific parameter settings, please check Page 20 "Effect List".

## Managing the Signal Chain

After choosing a module in the Edit Menu, you can hold PARA to enter the Manage Signal Chain menu:

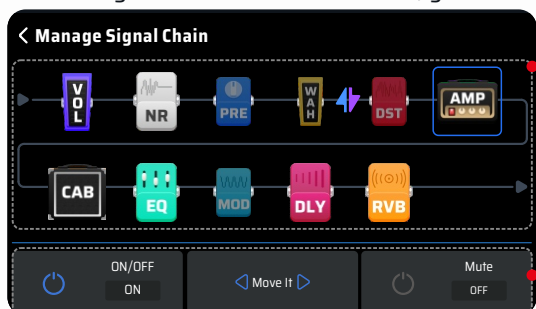

In this menu, turn PARA knob to select the module you want to move.

- Quick Access Knob 1 controls the on/off of the selected module;
- Quick Access Knob 2 controls moving the selected module;
- Quick Access Knob 3 offers a Mute Mode (only applicable in this menu) to avoid possible noise when moving the effect module.

Press and hold PARA or click BACK to return to the Edit Menu.

# Patch Setting

Note:

- In some extreme cases the signal processor may become overloaded and display a “System Overload” message. Please try other effects combos instead.
- Keep in mind that turning the modules on/off and adjusting parameters will change the current patch. If you switch patches or turn GP-200LT off before saving your changes, the changes will be lost. Make sure to press the SAVE button to save your settings.
- In EDIT Menu, footswitches function the same as in the Main Display screen.

## Patch Settings

Patch Settings is referred to functional settings that can be independently saved in different patches. It offers settings to CTRL, footswitches, Quick Access Knobs, patch volume, patch pan, patch tempo(BPM) and so on.

When the icon selects patch settings, use the quick access knobs to adjust patch volume, patch pan and patch tempo(BPM).

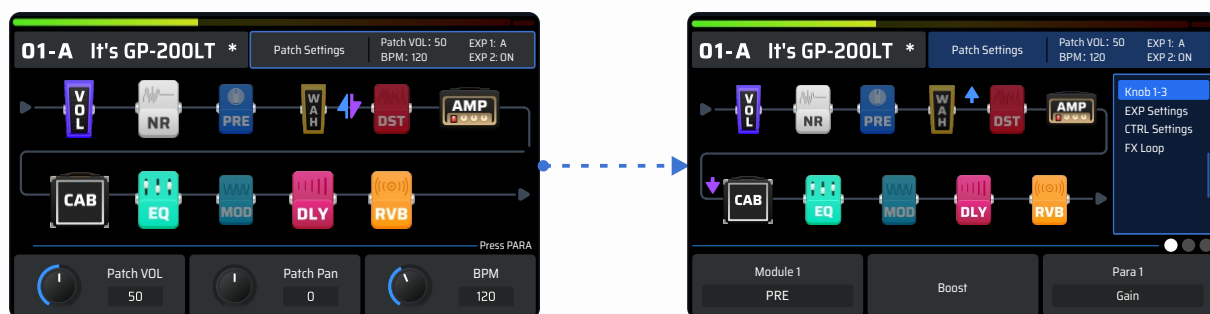

**Knob 1-3:** To use the Quick Access Knobs for adjusting effect parameters of the selected patch.



**EXP Settings:** Settings of the selected patch’s expression pedal, including EXP 1A, EXP 1B and EXP 2. Every pedal mode can simultaneously control up to 3 effect parameters with max/min value settings. EXP 2 means external pedals, you can use them through Global Settings.

Note:

EXP pedal-related parameters are regarded as module parameters, and no save reminder will be shown up.

**CTRL Settings:** You can assign the on/off of one or multiple modules, and there are totally 4 CTRLs available. When used with “Global Settings”, you’re able to control multiple modules’ on/off in one patch, making you feel like playing with the stompbox matrix.

**FX Loop:** the FX Loop settings in the current patch.

Blue arrow  : the signal is sent from here. Purple arrow  : the signal is returned here.

The Send/Return nodes can be freely moved in the effect chain.

Note:

The return node can’t be placed in front of the send node to avoid the squealing sound.



## Patch Setting

- Parallel/Series illustrates how the effects loop is connected to the signal chain.
  - When set to Parallel, the returned signal from external effect chains will mix with the AMP module and be sent to the latter signals in the signal chain.
  - When set to Series, internal effect chain will be temporarily paused, only signals from external effect chains will be sent to the latter signals in the signal chain. In this situation, if the effect loop interface is not connected to the any other effect unit, the GP-200LT output will remain silent.



### Save Menu

In the Save menu, you can save the changes you make to your effects parameters, control information, and other editable targets.

When pressing SAVE button, the interface will enter Save Menu, choose a slot via rotating and pressing PARA. Press it to enter Rename Menu. Hold SAVE to jump renaming and position change and save directly.

In the Rename Menu, you can manage your editing through PARA knob or 3 Quick Access Knobs.

- Quick Access Knob 1: There are 4 types of characters to choose from: Uppercase, lowercase, numbers and symbols (including space).
- Quick Access Knob 2: Switch the position of the icon.
- Quick Access Knob 3: Delete the icon targeted character.
- When finishing, press SAVE to make sure you saved.
- Click BACK to exit editing and return to the previous menu.

Remember to save after finishing the editing.

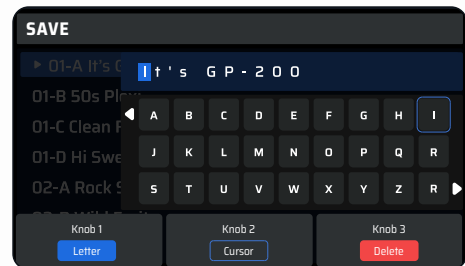

## Global Settings

Global Settings, unlike previous ones, will affect the whole status of the GP-200LT and not change when the patch has changed. All the settings will immediately function when editing is finished. There are input/output, USB Audio, footswitch/EXP pedal, language and more in this menu, as well as factory reset.

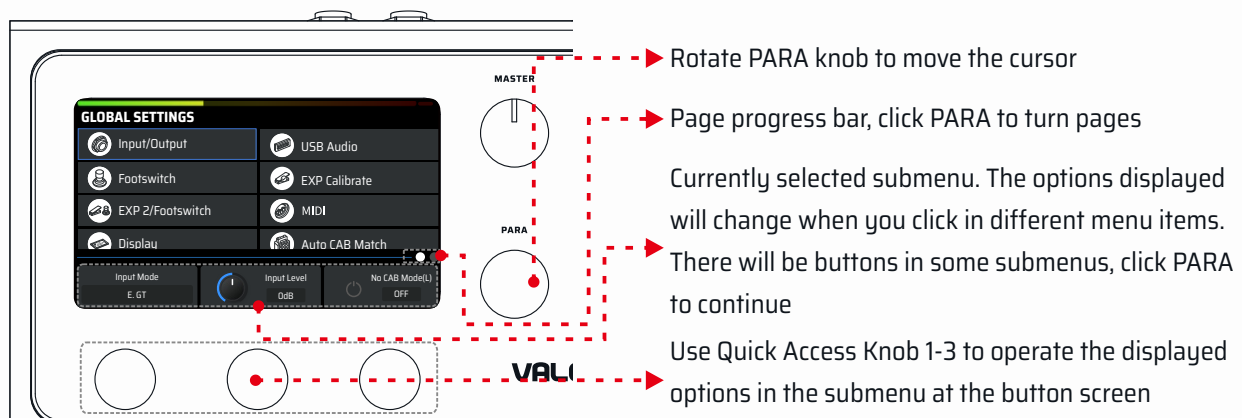

# Global Settings

## Input/Output

This option is to adjust input/output related parameters.

- **Input Mode:** to adjust the impedance, including acoustic guitars, electric guitars and line in.
  - Acoustic guitar: Impedance set to 4.7MΩ, used to connect acoustic guitars or piezoelectric pickups.
  - Electric guitar: Impedance set to 1MΩ, used to connect electric guitars and bass guitars with pickups.
  - Line in: Impedance set to 10kΩ, used to connect synthesizers and more analog audio devices.
  - The default option is set to electric guitar.
- **Input Level:** Ranged from -20dB to +20dB with default value set to 0dB, you can adjust the value to get the best experience based on varied instruments.

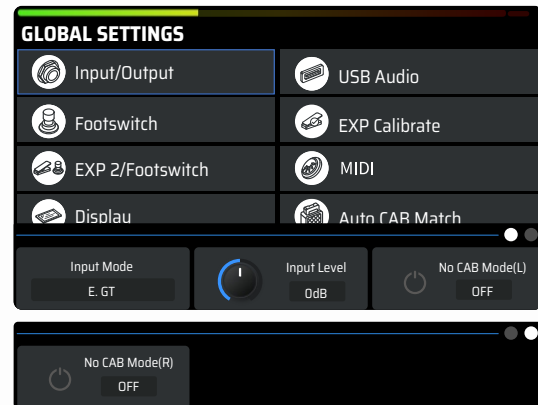

- **No CAB mode(L/R):** By activating no CAB mode on Mono left or right, you can get the audio effect where there is no CAB module simulation in the analog output. The default is off.

## USB Audio

This is to adjust related settings when using the GP-200LT as a USB audio interface.

- **Rec Level:** To control the master volume of the output when recording, ranged from -20dB to +20dB. The default is 0dB.
- **Rec Mode Left/Right:** GP-200LT has a USB stereo analog output channel. When choosing Dry, the corresponding output channel will send out direct signals; when choosing Wet, the corresponding output channel will send out signals with effects. This function can easily achieve “monitor wet, record dry”. The default is wet.
- **AUX To USB:** When activating, audios from AUX IN can be recorded in USB devices. This means, when using GP-200LT for livestreaming, you can mix the audios from AUX IN with effects from the GP-200LT, and send out to the streaming device through USB output.
- **Monitor Level:** To control the volume of playback through USB, ranged from -20dB to +20dB. The default is 0dB.
- **USB mode:** switch to a multi-channel output. Legacy mode: switch to this mode for a 2x2 USB audio without MIDI function, this mode is compatible with the OTG function of most phones(connection to GP-200LT software will be lost). Normal mode: switch to this mode for a 6 x 4 USB audio with MIDI function, this mode is compatible with using this device as a soundcard.

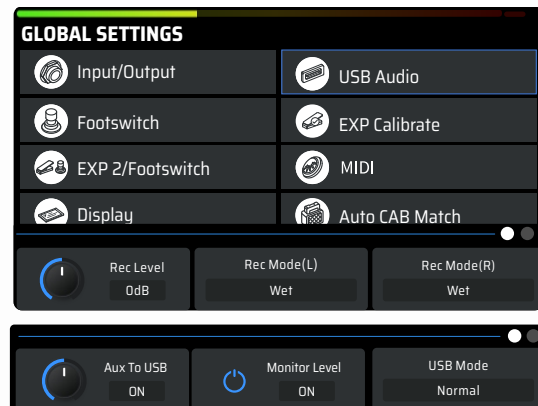

# Global Settings

## Using GP-200LT as an audio interface

When used as a USB audio interface, the GP-200LT will be recognized by the system as a 6-in/4-out USB device. Here we will show you how to use this function through listing two scenarios.

**Scene 1:** Using the built-in re-amp function in the DAW to record or adjust the tone

1. Set the Mono L and Mono R's output to "Dry" in the Global Settings-USB Audio
2. In the DAW, create two new Tracks A and B, and import/record a dry guitar Track in A
3. Set Track A output to Output 3-4, set Track B input to Input 3-4, keep Track B's monitoring off
4. Play the dry track in DAW, and now you can hear the effect sound of the processed dry track file in GP-200LT
5. Activate "Record" in Track B on the recording software, then you'll get to record the Track with effect after re-amp on Track B.

**Scene 2:** Using LOOPBACK function to record, combining the audio from multiple sources on your computer

1. In the DAW, create a new stereo audio track
2. Set the input to Input 5-6
3. Start recording in the DAW
4. By playing other audio sources on your computer, you can record them in the track now

## Footswitch

This is for choosing footswitch modes and corresponding function settings.

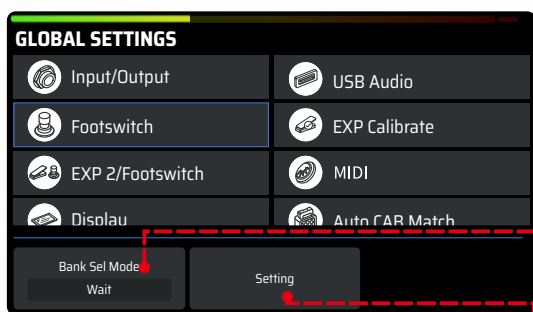

- Quick Access Knob 1 is to choose Bank Select Mode. This setting simultaneously affect internal and external footswitches and offers two modes: Initial and Wait.
  - Initial: When switching banks, the patches will roll immediately.
  - Wait: The default mode. When switching banks, the patches will NOT roll immediately, instead, you will need to enable footswitch functions and select a confirmed patch number. After that, the patches will switch.
- Quick Access Knob 2 is to enter Footswitch Setting (See picture below).

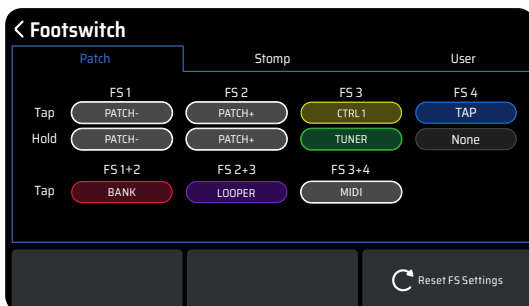

There are 3 footswitch modes: Patch mode, Stomp mode and User mode. In each mode, all options are the same with varied default settings. All functions will work immediately when selected and presented. All changes will be saved automatically.

You can also click PARA to enter Footswitch Setting, and assign tap and hold functions for each footswitch. By fast-selecting which footswitch to assign functions, tap the corresponding footswitch.

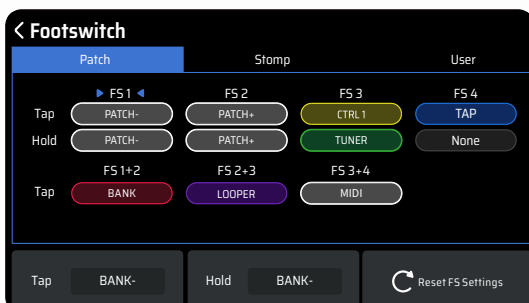

- Turn Quick Access Knob 1 to select tap functions
- Turn Quick Access Knob 2 to select hold functions
- Turn Quick Access Knob 3 to perform a factory reset for this mode

# Global Settings

Footswitch functions include:

Function	Description
Bank	Enter bank selecting menu
Bank+	Load the latter adjacent bank
Bank-	Load the former adjacent bank
Patch+	Load the latter adjacent patch
Patch-	Load the former adjacent patch
A	Load the A patch
B	Load the B patch
C	Load the C patch
D	Load the D patch
LOOPER	Enter the Looper
DRUM	Play/stop the drum

Function	Description
Drum Patch+	Load the latter adjacent drum patch
Drum Patch-	Load the former adjacent drum patch
EXP 1 A/B	Switch between A/B of EXP 1
MIDI	Enter the MIDI function interface
BYPASS	Enter the bypass state
TUNER	Enter the tuner
CTRL 1	Execute CTRL 1's function
CTRL 2	Execute CTRL 2's function
CTRL 3	Execute CTRL 3's function
CTRL 4	Execute CTRL 4's function
Tap Tempo	Use Tap Tempo

## EXP Calibrate

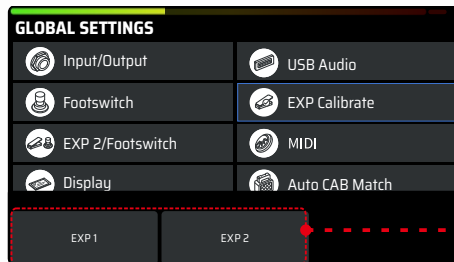

The EXP Calibrate helps you calibrate your expression pedal. It is important to do so if you find the sweep has very little or too much change in the effect you've set.

As shown, turn Quick Access Knob 1 or 2 to calibrate EXP pedal 1 or 2.



Lift your pedal all the way up, and click PARA to continue.



Press the pedal all the way down, and click PARA to continue.



Press the front side strongly, and click PARA to continue.

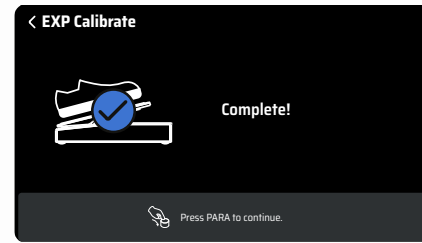

If successfully calibrated, the screen will display as so.

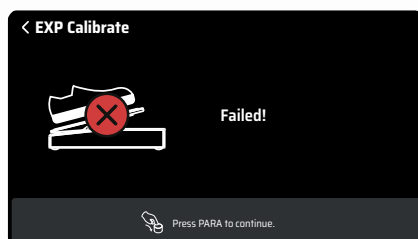

If not, the screen will display as so. Please try to repeat the process. You can also click BACK to return to the previous menu.

# Global Settings

## EXP 2 / Footswitch

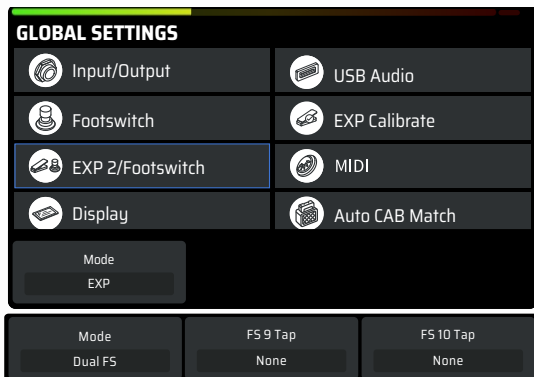

This menu is to adjust parameters related to external devices through EXP/FS input. Click PARA to select whether to set EXP/FS 1 or EXP/FS 2 in the Quick Access menu.

You need to set up for the type of the external devices. If it is an external pedal, you'll need to manage the parameters in "Patch Settings - EXP Settings"; if it is a single footswitch or dual footswitch, the options in the Quick Access menu will help you set up.

## MIDI

This menu is to set up MIDI messages, including MIDI In Source, Input Channel (TRS), Input Channel (USB), Output Channel (TRS), Output Channel (USB), Clock Source, Clock Out (TRS) and Clock Out (USB).

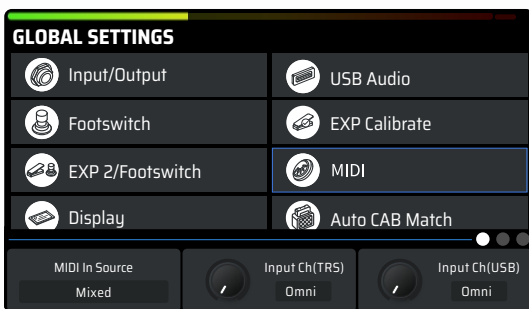

**MIDI In Source:** Control where the MIDI message is coming from.

**Input Channel (TRS), Input Channel (USB), Output Channel (TRS), Output Channel (USB):** For setting up the channel of the

USB input and the MIDI messages' input and output

**Clock Source:** For choosing the source of the MIDI clock.

**Clock Out (TRS), Clock Out (USB):** To control whether the MIDI OUT and USB will send out MIDI clock messages. Use this to set your GP-200LT as the main clock for all MIDI devices.

Parameters	Range	Description	
MIDI In Source	TRS Only	Only receiving MIDI messages from the MIDI IN.	
	USB Only	Only receiving MIDI messages from the USB.	
	Mixed	Receiving from both the MIDI IN and the USB.	
Input Channel (TRS)	Omni ~ 1 ~ 16 (The default setting is Omni)	For setting up the channel of the USB input and the MIDI messages' input and output	
Input Channel (USB)			
Output Channel (TRS)			
Output Channel (USB)			
Clock Source	Internal	Only receiving from the internal clock	
	TRS Only	Only receiving the clock messages from the MIDI IN	When "TRS Only", "USB Only" or "External" is selected, the internal clock will not work and the Tap Tempo will not function
	USB Only	Only receiving the clock messages from the USB	
	External	Only receiving from the external clock	
	Mixed (Default)	Receiving clock messages from the internal clock, MIDI IN and USB. If using different clock sources simultaneously, then the last message type the GP-200LT receives will cover previous ones	
Clock Out (TRS)	ON/OFF (The default is OFF)	When turned ON, this unit will negate all input signals; Additionally, when your Clock Source is set to "TRS Only" or "USB Only", this unit will not send out MIDI clock messages.	
Clock Out (USB)			

# Global Settings

## Display

This menu is to adjust parameters and settings of the displayed factors.

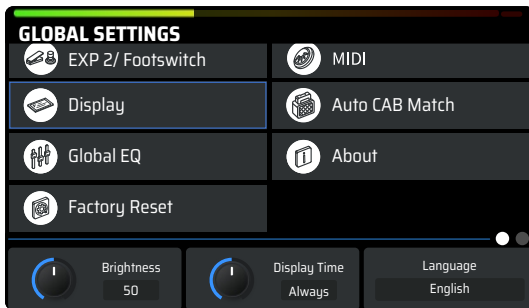

- Brightness: For adjusting screen brightness
- Display Time: The time GP-200LT needs to enter sleep mode.
- Language: For choosing your system language.
- Display Mode: Personalize the important information displayed in the main interface. Switch between these modes according to your preferences.
  - Footswitch: the current setting of the footswitch.
  - Patch: magnify the patch names and numbers.
  - Signal chain: display the current signal chain and the module's status.



Footswitch



Patch

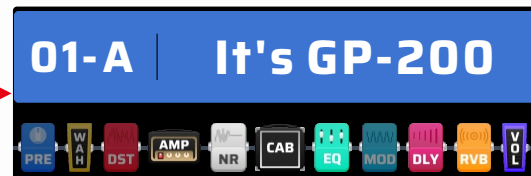

Signal chain

## Auto CAB Match

This is to turn on/off the correlation status of the AMP module and the CAB module.

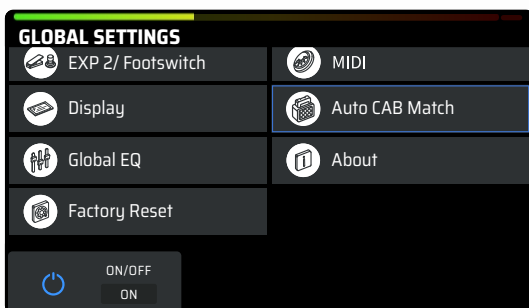

When turned ON, the effects in the CAB module will correspondingly change with the effects in the AMP module.

# Global Settings

## Global EQ

This menu is to control the global equalizer of the GP-200LT in order to change the overall tone feel.

This is the displayed menu:

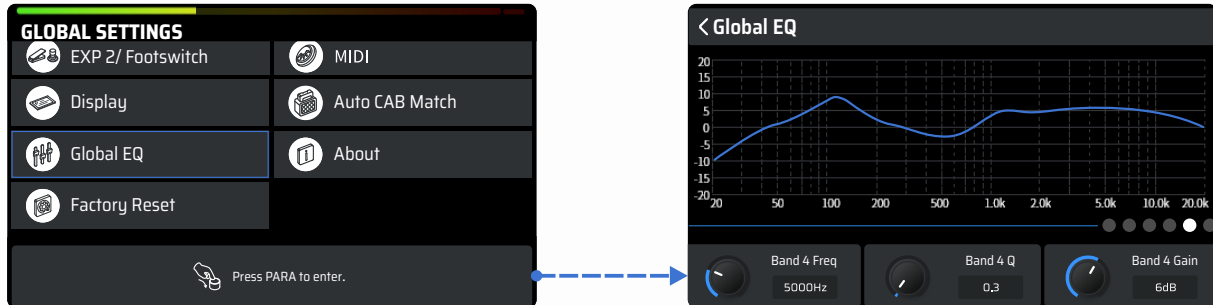

Global EQ contains Low Cut / High Cut, and 4 bands of parametric EQ. Every frequency band can be freely turned on/off based on your needs. There are total 6 of them.

Parameter		Range	Description
ON/OFF		ON/OFF	On/Off global EQ
Level		0~100(Default: 50)	Adjust the master volume of the global equalizer
Low Cut		OFF~20Hz~20000Hz (Default: OFF)	High pass filter to cut off low frequency signals.
Band 1-4: 4 selectable peak filters used for overall or detailed frequency adjustment in the certain range, including 3 available parameters: Frequency, Q and Gain.	Band 1-4 Frequency	20Hz~20000Hz (Band 1-4's default frequencies are accordingly 100Hz, 500Hz, 1000Hz and 5000Hz)	To adjust the corresponding filter's frequency.
	Band 1-4 Q	0.1~10.0 (Default: 0.71)	Width. To adjust the width of the formant (slope of the filter), the larger the number, the steeper the slope.
	Band 1-4 Gain	-20dB ~ +20dB (Default: 0dB)	Adjust the filter gain
High Cut		20Hz~20000Hz~OFF (Default: 20000Hz)	Low pass filter to cut off high frequency signals.

### Note:

- Please stay cautious when adjusting your global EQ to protect your hearing and device
- Global EQ won't affect the USB audio output of the GP-200LT
- When a patch is using too many modules, or some modules are consumed with too much system resources (such as reverb effect), the system may be overloaded after applying global EQ.

# Global Settings

## About

This menu is to check the firmware and hardware version.

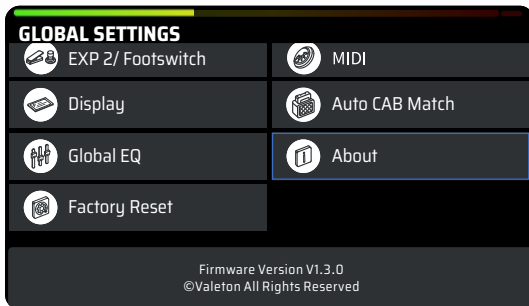

## Factory Reset

This menu is to perform a factory reset. Remember, resetting the GP-200LT will delete all of your saved changes and personal settings. Once it is executed, it cannot be undone. Please back up your settings before performing a factory reset.

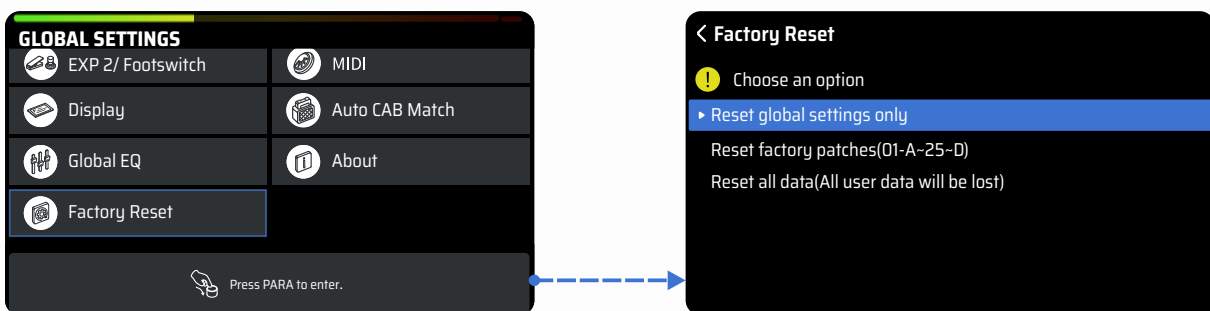

To improve the precision of factory reset function, the GP-200LT provides 3 types of factory reset. When clicking PARA to enter the menu, the screen will display with 3 options:

- Reset global settings only
- Reset factory patches (01-A~25-D)
- Reset all data (All user data will be lost)

When selecting one of them, there will be another window for confirming. When clicking OK, the factory reset will be performed. When clicking Cancel, it will return to the global settings menu.

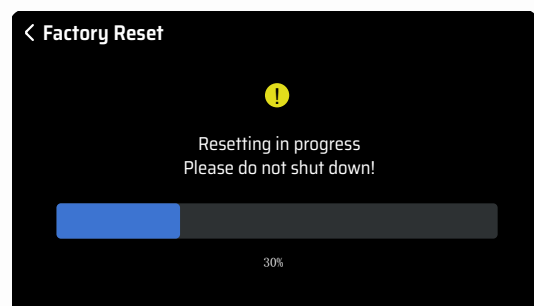
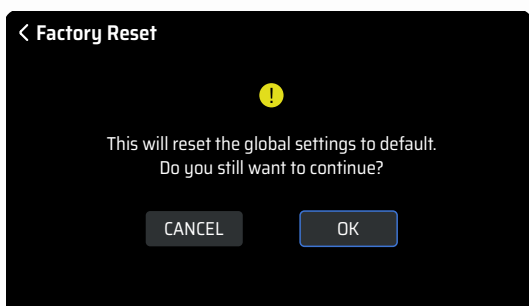

After the factory reset is performed, the screen will display this window to indicate it is now on factory resetting. Please remember, never turn off the power when performing the factory reset, otherwise the GP-200LT may malfunction.

## Global Settings

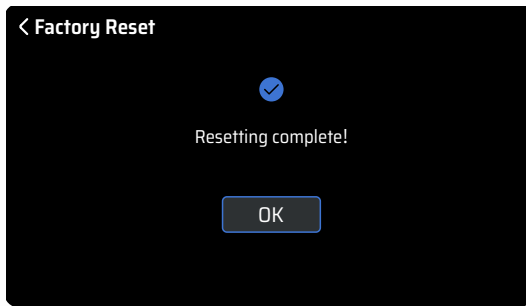

When it is all set, the screen will suggest the resetting is complete. Click OK to return to the Main Display menu.

### Note:

To maintain the capability for interaction, factory reset won't affect the language you have chosen.

## Compatible software

When you connect your GP-200LT with the PC/Mac, you can use the free GP-200LT software to manage multiple functions, including adjusting tones, import/export patches, firmware upgrade, loading 3rd party IRs and more. The GP-200LT software supports both Windows and MacOS platforms. Please download the software at [www.valeton.net/support](http://www.valeton.net/support).



### Note:

Before connecting the computer, make sure that it is set to "Normal" under "GLOBAL SETTINGS - USB Audio - USB Mode"

## Application Scenarios

In this section, we will introduce the connection methods of GP-200LT in common usage scenarios.

### With full-range speaker devices

Full-range devices include audio interface, studio monitor, PA system, headphones etc. In this scenario, the output jack or headphone jack of the GP-200LT can be connected according to the need of subsequent devices. Use 1/4" TRS cable for balanced signal output, and the balanced output is more suitable for long-distance signal transmission.

If there is only one speaker, please select the L (MONO) first.

To get the best tonal performance, keep the AMP and CAB modules ON and keep the "No CAB" mode off.

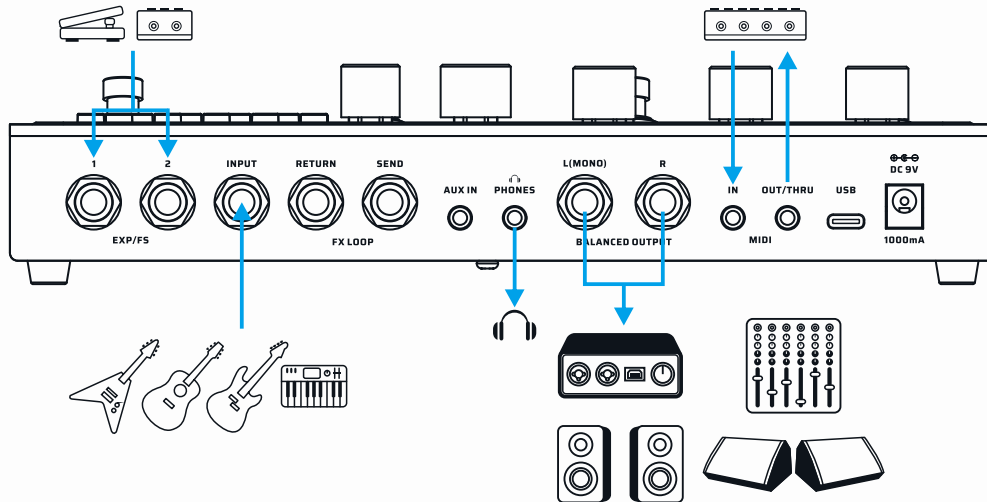

### With guitar amps (INPUT jack)

In this scenario, directly connect the GP-200LT's BALANCED OUTPUT to the guitar amp's INPUT.

If only one amp is available, please select the L (MONO) first.

To get the best tonal performance, keep the AMP and CAB modules off to avoid adverse effects on the tone.

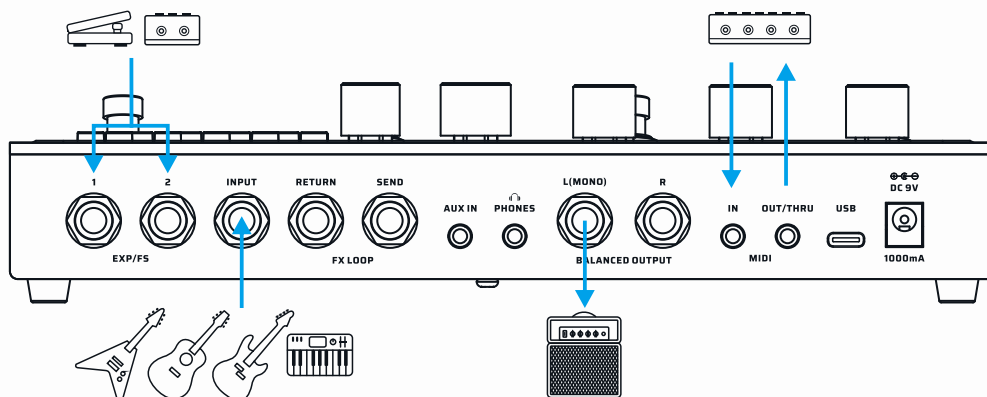

## Application Scenarios

### With guitar amps (using FX Loop to pre-position the GP-200LT)

In this scenario, connect the GP-200LT's BALANCED OUTPUT to a guitar amp's RETURN.

This way, by bypassing the preamp and using the power amp of the guitar amp to pair with dozens of refined effects in the AMP module, you'll get the more realistic sound.

If only one amp is available, please select the L (MONO) first.

To get the best tone performance, keep the CAB module off or turn on the "No CAB" mode to avoid adverse effects on the tone.

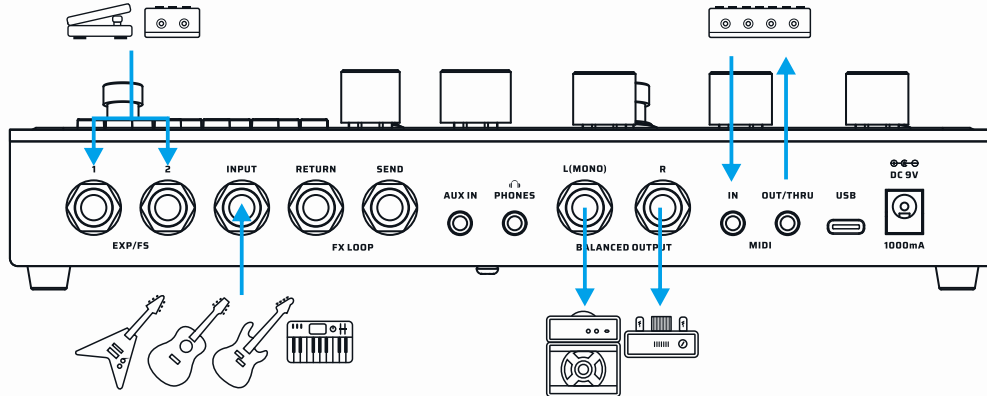

### With guitar amps (using FX Loop to post-position the GP-200LT)

In this scenario, all modules before the AMP (including the AMP module) will be muted, and the effect chain after the AMP module will be applied between the preamp and the power amp. In default setting, RETURN node is after AMP Module.

In order to get the best tone performance, keep the CAB module off or turn on the "No CAB" mode to avoid adverse effects on the tone.

In addition, you need to pay attention to the GP-200LT's patch volume monitor, if you hear the "clip" sound, please reduce the input volume in the "Global - Input/Output", or adjust the input to Line to try get the more ideal tone.

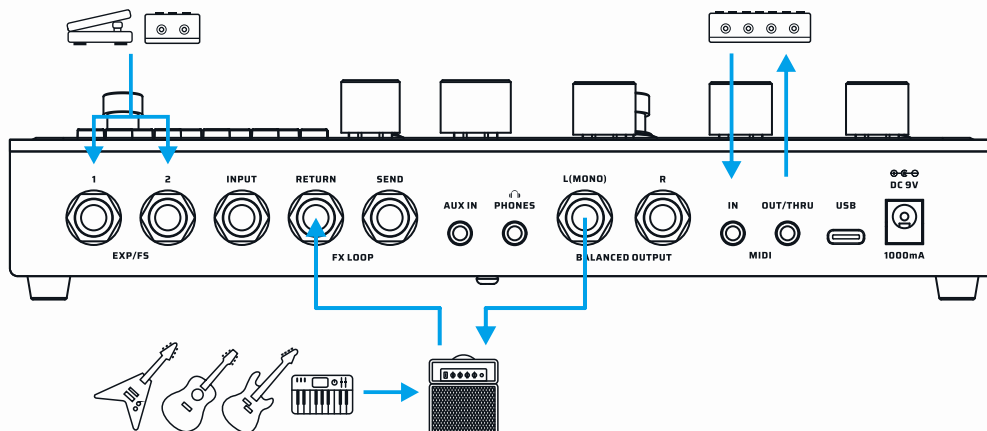

## Application Scenarios

### With guitar amps (using FX Loop to run the 4 cable method)

This method will split the GP-200LT's effect chain into two parts (as shown below). It allows you to place the GP-200LT's PRE and DST modules before the preamp, while placing the EQ, MOD, DLY and RVB modules between the preamp and the power amp.

In order to get the best tone performance, please keep the AMP and CAB modules off to avoid any adverse effect on the tone.

Also note that please set the FX Loop at Series mode in the "Patch Settings - FX Loop - Parallel/Series" to "Series".

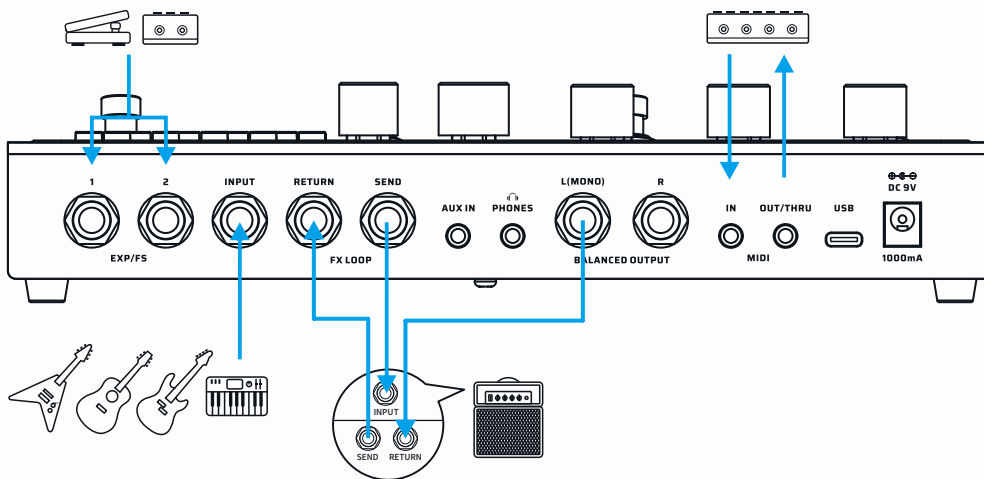

### With other pedals

Place the GP-200LT where you want it in your pedalboard, or use the GP-200LT's FX Loop function to make the GP-200LT the master device in your effects chain.

Please make sure that the input and output jacks of the GP-200LT are properly connected to the pedals.

If using the FX Loop function, please set the FX Loop related parameters/options as desired in the patch settings.

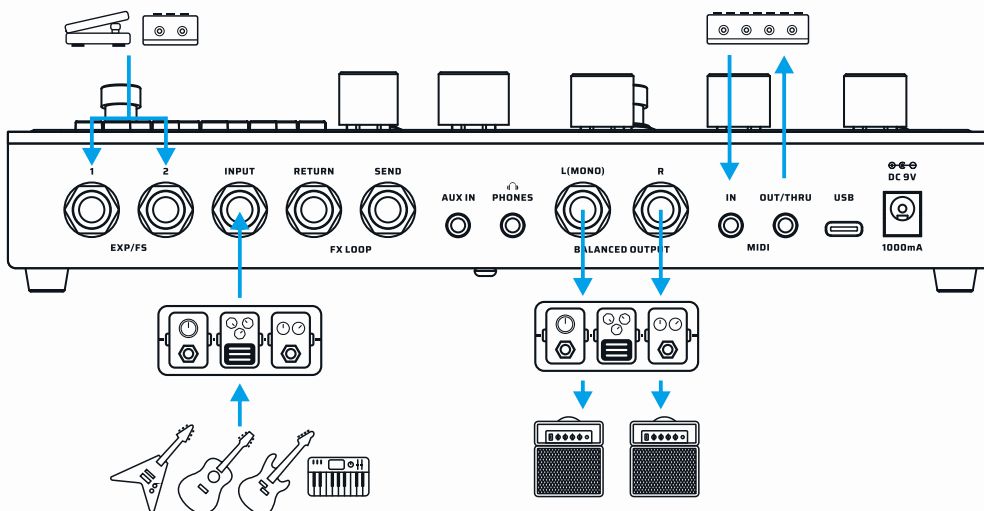

## Application Scenarios

### Audio Studio (for livestreaming)

In this scenario, the GP-200LT will be functioned as an audio interface for a computer or a cellphone. The MASTER knob and PHONES knob control monitors and headphone volume, respectively. Use the supplied USB cable to connect to the computer; if connecting to a cell phone, an additional OTG adapter cable may be required. When under Windows system prior to Windows 10, it needs to be used with the ASIO driver available for downloading on the Valeton official website; while on MacOS, iOS, Android and Windows system after Windows 10, it can be easily plugged in and played. The input signal (INPUT) and the auxiliary input signal (AUX IN)\* of the GP-200LT can be used by all the devices connected to the USB.

\*Please make sure the "Global - USB Audio- AUX IN USB" function is enabled.

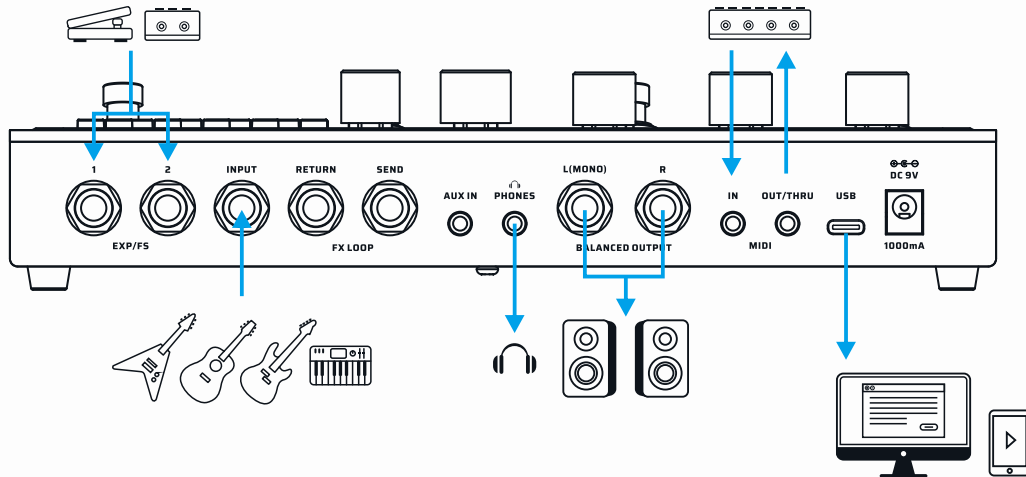

## Effect List

PRE			
FX Title	Type	Description	Parameter Description
COMP	Comp	Based on the legendary Ross™ Compressor. This is the originator of the guitar compression effect. It brings the guitar compression effect to the public and becomes an important element in the future. It has a very natural and mellow compression effect.	Sustain: Controls the compression amount Volume: Controls the effect output
COMP4	Comp	Based on the Keeley® C4 4-knob compressor*. A recording studio - level compression effect. Clear sense of hierarchy, the right amount of high frequency makes your guitar sound brighter.	Sustain: Controls the compression amount Attack: Controls how soon the compressor starts to process the signal Volume: Controls the effect output Clipping: Controls the input sensitivity
S-Comp	Comp	Flexible, fully adjustable compressor effect	Threshold: Controls the compression trigger level Ratio: Controls the amount of compression when the compressor is triggered Volume: Controls the output volume/makeup amount Attack: Controls how soon the compressor starts to process the signal Release: Controls how soon the compressor starts to release the signal level back to normal after the level drops below the threshold Tone: Controls the effect tone Blend: Controls the wet/dry signal ratio
Micro Boost	Boost	Based on the legendary MXR® M133 Micro Amp pedal. Providing up to 20dB of gain, the Micro Boost elevates your amp sound without changing its tonal character.	Gain: Controls the gain amount
AC Boost	Boost	Based on famous Xotic® AC Booster* pedal, It is a beautiful smooth sounding drive/boost pedal that is perfect for giving your tube amp a bit of extra grunt.	
B-Boost	Boost	Any guitarist can benefit from the Xotic® BB Preamp* overdrive pedal. The pedal works equally well for getting thick and creamy overdrive tones with great sustain as it does for pushing the clean front end of an already driven amp with up to 30dB of boost.	
P-Boost	Boost	Based famous on Xotic® RC Booster* provides you with super-transparent 20dB boost without altering your carefully crafted tone. And it offers an added gain channel for extra fatness. Take advantage of the +/-15dB range on the treble and bass EQ controls, and imbue your guitar sound with unbelievable harmonic complexity. The EQ controls also compensate for the extra bass boominess the volume boost may cause and are great for matching the response for multiple guitars.	Gain: Controls the gain amount Volume: Controls the effect output Bass/Treble: 2-band EQ that controls the effect tone

\*The manufacturers and product names mentioned above are trademarks or registered trademarks of their respective owners. The trademarks were used merely to identify the sound character of the products

## Effect List

PRE			
FX Title	Type	Description	Parameter Description
14 Boost	Boost	Based famous on Fortin®Grind*. It gives you up to +20dB of boost that will tighten up and add aggression to any tube or solid-state amplifier. The GRIND's surprising low noise floor and high input Z lets every nuance of instrument character come through unaltered.	Gain: Controls the gain amount
FAT BB	Boost	This is a clean boost and preamp with a switchable low-cut filter and separate bass and treble controls.	Bass/Treble: 2-band EQ that controls the effect tone Volume: Controls the effect output Low Cut: Switches the low cut filter (-6dB/oct @200Hz) on/off
Boost	Boost	Based on famous Xotic® EP Booster* pedal. Provides +20DB of pure stimulation lift, strong low frequency, bright high frequency, making clear sound more pleasant.	Gain: Controls the gain amount +3dB: Selects the minimum boost amount from 0dB (off) to +3dB (on) Bright: Selects the sound character from vintage (Bright off) to flat (Bright on)
AC Refiner	Acoustic	Designed for acoustic instruments, bringing you a more natural "woody" acoustic sound	Shape: Controls the detailed effect character
AC Sim	Acoustic	Acoustic guitar simulator designed for guitars. Its prototype comes from a classic acoustic guitar analog stompbox.	Body: Controls the "body resonance" (low frequency response) Top: Controls the upper harmonics (high frequency response) Volume: Controls the effect output level Mode: Selects from 4 different sound characters: Standard: Simulates the tonal characteristics of a standard acoustic guitar Jumbo: Simulates the tonal characteristics of a jumbo acoustic guitar Enhanced: Simulates the tonal characteristics of an acoustic guitar with enhanced attack Piezo: Simulates the sound of a piezo pickup
T-Wah	Filter	Control the wah sound by playing intensity. A wide range d envelope filter (a.k.a. touch wah) designed for guitarists and bassists that is touch-sensitive and flexible	Sens: Controls the effect sensitivity Range: Controls the frequency range of the filter Q: Controls the sharpness of the filter Mix: Controls the wet/dry signal ratio Mode: Selects from two modes: Guitar/Bass

\*The manufacturers and product names mentioned above are trademarks or registered trademarks of their respective owners. The trademarks were used merely to identify the sound character of the products

# Effect List

PRE			
FX Title	Type	Description	Parameter Description
A-WAH	Auto Filter	Set the rate to make the wah pedal work regularly. Providing a variable auto wah effect for both guitars and basses.	Depth: Controls the effect depth Rate: Controls the effect speed Volume: Controls the output level Low: Controls the bottom point of center frequency (low freq) Q: Controls the sharpness of the filter High: Controls the top point of center frequency (high freq) Sync: Switches Tap Tempo sync on/off
Step Filter	Filter	A 4-step auto filter machine for creating synth-like sounds	Step 1-4: Controls the filter center frequency of each step Rate: Controls the sequencing speed Sync: Switches Tap Tempo sync on/off
OCTA	Pitch	Provides polyphonic octave effect.	Low Oct: Controls the volume of lower octave (1 oct down) High Oct: Controls the volume of higher octave (1 oct up) Dry: Controls the dry signal level
Pitch	Pitch	Polyphonic pitch shifter/harmonizer.	Low/Hi Pitch: Controls the low/high pitch shifting range by semitones Dry: Controls the dry signal level Low/Hi Vol: Controls the low/high pitch volume
P-Bend	Pitch	Polyphonic pitch shifter/harmonizer.	Low/Hi Pitch: Controls the low/high pitch shifting range by semitones Wet: Controls the wet signal level Dry: Controls the dry signal level Range: Controls the pitch range of harmony effect
Ring Mod	Special	A ring modulator for creating interesting inharmonic frequency spectra (like bells and chimes).	Mix: Controls the wet/dry signal ratio Freq: Controls the overall modulation frequency Fine: Fine tune the modulation frequency by +/- 50Hz Tone: Controls the effect tone
Saturate	Special	Vintage tape saturation simulator providing analog warmth and natural distortion.	Saturation: Controls the effect gain Mix: Controls the effect wet/dry signal ratio Volume: Controls the effect output volume High Cut: Cuts the effect high frequency signal

\*The manufacturers and product names mentioned above are trademarks or registered trademarks of their respective owners. The trademarks were used merely to identify the sound character of the products

## Effect List

WAH			
FX Title	Type	Description	Parameter Description
V-Wah	Wah	Based on legendary VOX® V846* wah pedal. The earliest wa-wah pedal was originally designed to allow the wind instrument passing through it to produce a more emotionally expressive "wa-wah" sound. The amplitude is small and acts between medium and high frequency.	Range: Controls the wah filter frequency range Q: Controls the wah resonance (filter Q) Volume: Controls the effect output When using the EXP pedal as a wah pedal, remember to first assign the position parameters, then turn on and press the pedal to get the effect.
C-Wah	Wah	Based on legendary Dunlop® CryBaby®* wah pedal. The classic 60's traditional wha pedal, acting between low and medium frequency, moderate amplitude, neutral timbre.	
P-Wah	Wah	Based on John Petrucci's rack wah settings, this Cry Baby® Wah features Volume, Q, and six EQ controls for ultimate tonal control over your wah sound.	Range: Controls the wah filter frequency range Q: Controls the wah resonance (filter Q) Volume: Controls the effect output EQ: Switches built-in EQ on/off When using the EXP pedal as a wah pedal, remember to first assign the position parameters, then turn on and press the pedal to get the effect.
S-Wah	Wah	Classic wah tone. Just press down and feel the vocal sweep and lush harmonics from the wah's classic era. Its like keeping a tiny jimmi hendrix in your pocket.	Range: Controls the wah filter frequency range Q: Controls the wah resonance (filter Q) Volume: Controls the effect output When using the EXP pedal as a wah pedal, remember to first assign the position parameters, then turn on and press the pedal to get the effect.
B-Wah	Wah	Wah designed for basses	

DST			
FX Title	Type	Description	Parameter Description
Green OD	OD	Based on legendary Ibanez® TS-808 Tube Screamer®* overdrive pedal. Since it was first shown to the world in 1979, TS808 has opened up a new world. There are countless guitarists who love it. It is a warm, delicate overdrive effect. Can be used as either an overdrive or a Boost, can be used in a variety of musical styles.	Gain: Controls the overdrive amount Tone: Controls the effect tone Volume: Controls the effect output
		Famous users: Stevie Ray Vaughan, Joe Satriani, Paul Gilbert, Andy Timmons, Kirk Hammett, Steve Ray Vanghan, Michal Landau, U2	
OD 9	OD	The Ibanez® Tube Screamer® is synonymous with the transparent overdrive tone used by many of today's top guitarists. The TS9 pedal boosts the guitar signal enough to drive the preamp stage of your amp, giving a very natural-sounding and pure overdrive and crisp rhythm crunch.	Gain: Controls the overdrive amount Tone: Controls the effect tone Volume: Controls the effect output
Yellow OD	OD	Artist of the 70's was mostly using a fuzz distortion sound and the overdrive produced by it was not typical. It was however soon accepted as the new standard of guitar sound. It features an asymmetric circuit where the positive and negative halves of the waveform isn't distorted equally. The sound is therefore still close to the original even though distortion have been added.	Gain: Controls the overdrive amount Volume: Controls the effect output

\*The manufacturers and product names mentioned above are trademarks or registered trademarks of their respective owners. The trademarks were used merely to identify the sound character of the products

## Effect List

DST			
FX Title	Type	Description	Parameter Description
Peneas	OD	Based on the legendary Klon® Centaur*, this overdrive model gives you an authentic amp-in-a-box feel with full, rich sound character that is not harsh or boomy at all. Turn Gain knob to minimum you get a superb clean boost.	Gain: Controls the gain amount Tone: Controls the effect tone Volume: Controls the effect output
Swarm	OD	The Providence® SOV-2 Stampede OD pedal is designed to deliver natural overdrive without obscuring the inherent characteristics and tone of the guitar being used. It features a special bipolar power supply that powers the internal circuitry with boosted voltage, providing a wider dynamic range than possible with conventional 9-volt powered overdrives. For singing lead tones and solid, chunky rhythms, there's nothing like the SOV-2 Stampede OD.	Gain: Controls the overdrive amount Tone: Controls the effect tone Volume: Controls the effect output
Super OD	OD	The unique asymmetric overdrive effect circuit adds warm and pleasant overdrive effect to the traditional guitar timbre.	
Scream OD	OD	Based on Tube Screamer® Style overdrive pedal, with unique timbre characteristics.	Gain: Controls the overdrive amount Tone: Controls the effect tone Volume: Controls the effect output Fat: Switches extra resonance on/off Air: Switches extra presence on/off
Blues OD	OD	Whether it's warm and natural overdrive or full open distortion, it gives your guitar the most expression, makes it easy to control the tone, and allows for subtle variations in your personal playing style.	Gain: Controls the distortion amount Tone: Controls the effect tone Volume: Controls the effect output
Force	OD	Fulltone® OCD* sounds like finding the "sweet spot" on your favorite amp. It produces overdriven tones that sound warm and full, with genuine tube-like response. There's no shortage of usable drive, meaning it dynamically ramps up overdriven grit from dirty overtones to saturated distortion in the smooth range of its drive control.	Gain: Controls the distortion amount Tone: Controls the effect tone Volume: Controls the effect output Mode: Selects from two different sound characters: HP (High Peak mode with more bottom end and distortion), LP (Low Peak mode without changing your original tone)
Blues Master	OD	The Marshall® BluesBreaker* is a low-gain pedal with exceptional transparent tone. Moderate overdrive and subtle boost are the strong points, though it can get as well emphatic with a cranked up tube amp.	Gain: Controls the distortion amount Tone: Controls the effect tone Volume: Controls the effect output
Master OD	OD	The EQ stage is extremely wide, offering treble, mid and bass shaping options and the gain stage goes from clean to a well driven JCM800 kind of tone and that is also where its magic lies. Famous users: Stevie Ray Vaughan, Joe Satriani, Paul Gilbert, Andy Timmons, Kirk Hammett, Steve Ray Vanghan, Michal Landau, U2	Gain: Controls the distortion amount Volume: Controls the effect output Bass/Middle/Treble: 3-band EQ that controls the effect tone
TaiChi OD	OD	Hermida® Zendrive® rose to fame because of its tube-like tone. To get the perfect balance of saturation and harmonics required to result in all of the 'in-tangibles' that make a pedal overdrive sound like a real amp overdrive. Things like touch sensitivity and response to guitar tone and volume control changes.	Gain: Controls the overdrive amount Tone: Controls the effect tone Volume: Controls the effect output Voice: Controls the upper harmonics character

\*The manufacturers and product names mentioned above are trademarks or registered trademarks of their respective owners. The trademarks were used merely to identify the sound character of the products

## Effect List

DST			
FX Title	Type	Description	Parameter Description
Timmy OD	OD	Paul Cochrane® Timmy* overdrive was one of the original boutique overdrive pedals, generating a dedicated following based on its open, un-compressed drive tone and good EQ options.	Gain: Controls the distortion amount Volume: Controls the effect output Bass/Treble: 2-band EQ that controls the effect tone Mode(I,II,III): Distortion type selection
Precise OD	OD	Horizon Devices® Precision Drive* overdrive. Perfect modern metal rig with precise tonal carving controls. The built-in noise gate ensures the cleanness and clarity of tone.	Gain: Controls the overdrive amount Tone: Controls the effect tone Volume: Controls the effect output Attack (1, 2, 3, 4, 5, 6): Overdrive type selection Gate: Controls the built-in noise gate threshold
Lazaro	Fuzz	Based on legendary Electro-Harmonix® Big Mu Pi®*fuzz/distortion pedal. It is very individual, warm and thick sound wall, restless but full of beauty.	Sustain: Controls the gain amount Tone: Controls the effect tone Volume: Controls the effect output
		Famous users: Jimi Hendrix, Santana, Pink Floyd, Jack White	
Red Haze	Fuzz	Based on legendary Dallas-Arbiter® Fuzz Face®* fuzz pedal. Dallas Arbiter conjured the sound of rock and roll for half a century in 1966 with a few simple transistors. The sound of Fuzz Face was heavy and sharp, and its sound influenced countless famous musicians.	Fuzz: Controls the gain amount Volume: Controls the effect output
		Famous users: Jimi Hendrix, Santana, Pink Floyd, Jack White	
Sora Fuzz	Fuzz	For fans of the aggressive germanium fuzz tones that could be wrought from those early units, there's nothing quite like the Sola Sound® Tone Bender*. The Tone Bender's circuit became massively popular, and over the following years its design rapidly evolved, making for a tangled and winding history that is intertwined with some of the most formative music made in the U.K. from the mid 1960s to the early '70s.	Fuzz: Controls the gain amount Volume: Controls the effect output
Plustortion	Fuzz	This little yellow box has produced lots of great soundings in countless classic studio albums. Yeah, we're talking the legendary MXR® M104 Distortion +*, and this M104-based Plustortion. The Plustortion recreated the Germanium-powered soft clipping distortion, like what Randy Rhoads and other hard rockers do!	Gain: Controls the distortion amount Volume: Controls the effect output
SM Dist	Distortion	It is based on a classic orange three-knob distortion effector, which can be used to easily get the timbre characteristics of the 70s-80s.	Gain: Controls the distortion amount Tone: Controls the effect tone Volume: Controls the effect output

\*The manufacturers and product names mentioned above are trademarks or registered trademarks of their respective owners. The trademarks were used merely to identify the sound character of the products

# Effect List

DST			
FX Title	Type	Description	Parameter Description
Darktale	Distortion	Based on legendary ProCo™ The Rat* distortion (early LM308 OP-amp version). The Rat* has come to life thanks to its wide range of Filter knob, bright and compact sound head, full end and strong plasticity, making it a favorite of many musicians.	Gain: Controls the distortion amount Filter: Counterclockwise controls the effect tone Volume: Controls the effect output
		Famous users: Je Beck, Kurt Cobain	
Chief	Distortion	The Marshall® Guv'nor* was released in 1988 and in production during 4 years. This overdrive/distortion Made in England effect replicates the classic tube Marshall® Amp sound into compact and solid state box featuring a sustainable gain with a touch of compression.	Gain: Controls the distortion amount Volume: Controls the effect output Bass/Middle/Treble: 3-band EQ that controls the effect tone
Master Dist	Distortion	The Marshall Shredmaster Distortion guitar effect pedal delivers face-melting distortion and that tone you can only get out of a Marshall. The pedal offers treble, bass, and contour knobs to tweak, twist, and deliver an unbelievable performance.	Gain: Controls the distortion amount Volume: Controls the effect output Bass/Contour/Treble: 3-band EQ that controls the effect tone
La Charger	Distortion	Based on MI Audio® Crunch Box®* distortion pedal. Sensitive and exquisite distortion beast, it satisfies all the passion of Riff and Solo. The response of each frequency band is balanced, the dynamic feedback is faithful to the fingertip, and the noise can be well controlled even at high gain.	Gain: Controls the distortion amount Tone: Controls the effect tone Volume: Controls the effect output
Flex OD	Bass Drive	A simple and effective distortion effect for guitars and basses.	Gain: Controls the overdrive amount Tone: Controls the effect tone Volume: Controls the effect output Mode: Selects from 3 different sound characters: Normal (neutral sound), Scoop (mid-scooped sound), Edge (edgy sound) Blend: Controls the wet/dry signal ratio
Bass OD	Bass Drive	This is an overload effect device specially designed for bass. It combines the original bass sound with a unique overdrive effect to make a very good distortion effect while ensuring The original bass dynamic tone. It can also be used as a pretty good boost.	Gain: Controls the distortion amount Blend: Controls the wet/dry signal ratio Volume: Controls the effect output Bass/Treble: 2-band EQ that controls the effect tone
Black Bass	Bass Preamp	Based on the Darkglass® Microtubes B7K*. Takes the powerful dynamic saturation circuit and adds a four-band equalizer and a balanced line driver for even greater versatility. Designed for both studio and live use, it will take your direct sound to a whole new level.	Gain: Controls the distortion amount Blend: Controls the wet/dry signal ratio Volume: Controls the effect output Low/Lo-mid/Hi-mid/Treble: 4-band EQ that controls the effect tone Attack(Cut,Boost,Flat): Controls the effect high frequency tone

\*The manufacturers and product names mentioned above are trademarks or registered trademarks of their respective owners.

The trademarks were used merely to identify the sound character of the products

## Effect List

DST			
FX Title	Type	Description	Parameter Description
Micro Boost	Boost	Based on the legendary MXR® M133 Micro Amp2 pedal. Providing up to 20dB of gain, the Micro Boost elevates your amp sound without changing its tonal character.	Gain: Controls the gain amount
AC Boost	Boost	Based on famous Xotic® AC Booster* pedal, It is a beautiful smooth sounding drive/boost pedal that it perfect for giving your tube amp a bit of extra grunt.	Gain: Controls the gain amount Volume: Controls the effect output Bass/Treble: 2-band EQ that controls the effect tone
B-Boost	Boost	Any guitarist can benefit from the Xotic® BB Preamp* overdrive pedal. The pedal works equally well for getting thick and creamy overdrive tones with great sustain as it does for pushing the clean front end of an already driven amp with up to 30dB of boost.	
P-Boost	Boost	Based famous on Xotic® RC Booster* provides you with super-transparent 20dB boost without altering your carefully crafted tone. And it offers an added gain channel for extra fatness. Take advantage of the +/-15dB range on the treble and bass EQ controls, and imbue your guitar sound with unbelievable harmonic complexity. The EQ controls also compensate for the extra bass boominess the volume boost may cause and are great for matching the response for multiple guitars.	Gain: Controls the gain amount Volume: Controls the effect output Bass/Treble: 2-band EQ that controls the effect tone
14 Boost	Boost	Based famous on Fortin® Grind*. It gives you up to +20dB of boost that will tighten up and add aggression to any tube or solid-state amplifier. The GRIND's surprising low noise floor and high input Z lets every nuance of instrument character come through unaltered.	Gain: Controls the gain amount
FAT BB	Boost	This is a clean boost and preamp with a switchable low-cut filter and separate bass and treble controls.	Bass/Treble: 2-band EQ that controls the effect tone Volume: Controls the effect output Low Cut: Switches the low cut filter (-6dB/oct @200Hz) on/off
Boost	Boost	Based on famous Xotic® EP Booster* pedal. Provides +20DB of pure stimulation lift, strong low frequency, bright high frequency, making clear sound more pleasant.	Gain: Controls the gain amount +3dB: Selects the minimum boost amount from 0dB (off) to +3dB (on) Bright: Selects the sound character from vintage (Bright off) to flat (Bright on)
AMP			
FX Title	Type	Description	Parameter Description
Tweedy	Clean	Based on Fender® Tweed Deluxe*. This amplifier with a dynamic range from clean to wild overdrive, from country rock to distortion, the Fender® Tweed Deluxe* has been a totem in every style for more than 60 years.	Gain: Controls the gain amount (pre gain) Tone: Controls the effect tone Volume: Controls the output volume (post gain)

\*The manufacturers and product names mentioned above are trademarks or registered trademarks of their respective owners. The trademarks were used merely to identify the sound character of the products

## Effect List

AMP			
FX Title	Type	Description	Parameter Description
Bellman 59N	Clean	Based on Fender® '59 Bassman®*. The most dramatic speaker in the history of Rock&Roll, originally designed for bass, has become the most classic guitar speaker.As clear as water, Vacuum tubemakes the sound more beautiful,make musical instrument manufacturers are eager to imitate the product.	Gain: Controls the gain amount (pre gain) Presence: Controls the effect headroom Volume: Controls the output volume (post gain) Bass/Middle/Treble: 3-band EQ that controls the effect tone
		Famous users: Stevie Ray Vaughan, Kurt Cobain	
Bellman 59B	Drive	Based on Fender® '59 Bassman®*.	
Dark Twin	Clean	Based on Fender® '65 Twin Reverb®*. With a Stratocaster*, the classic sound can be easily restored in both country jazz and rock music.	Gain: Controls the gain amount (pre gain) Volume: Controls the output volume (post gain) Bass/Middle/Treble: 3-band EQ that controls the effect tone Bright: Switches extra brightness on/off
Dark DLX	Clean	Great clean tones are possible, but the versatile "sweet distortion" is what so many guitarists appreciate and love with the Deluxe. Therefore the amp is the number 1 for many blues musicians, as well as for modern super guitarists. The fender-typical spring reverb and a tube vibrato effect allow even more "vintage"- sound variants.	Gain: Controls the gain amount (pre gain) Volume: Controls the output volume (post gain) Bass/Treble: 2-band EQ that controls the effect tone
Dark Vibra	Clean	The original (6G16 circuit) Vibroverb was introduced in February 1963. The speaker lineup and the output transformer were based on the Fender Super amp of the time and the circuit based on the Fender Vibrolux of the time. The 40-watt amplifier boasted two channels (NORMAL and BRIGHT). Both channels had VOLUME, TREBLE and BASS controls; the single-control REVERB affected only the BRIGHT channel.	Gain: Controls the gain amount (pre gain) Volume: Controls the output volume (post gain) Bass/Treble: 2-band EQ that controls the effect tone Bright: Switches extra brightness on/off
Silver Twin	Clean	Fender® Silverface Twin Reverb* amplifiers were built between 1967 and 1981. It makes the sound of history.	Gain: Controls the gain amount (pre gain) Volume: Controls the output volume (post gain) Bass/Middle/Treble: 3-band EQ that controls the effect tone
SUPDual CL	Clean	Based on the Supro®Dual-Tone 1624T* (CH1 clean tone). In the mid 60's , vintage 1624T amps have been sought-after for decades because the Dual-Tone's volume knob is turned beyond noon, a fat and compressed clean tone evolves into an immediately recognizable grind that remains articulate and listenable even when turned up to full blast.	Gain: Controls the gain amount (pre gain) Tone: Controls the effect tone Volume: Controls the output volume (post gain)
SUPDual OD	Drive	Based on the Supro®Dual-Tone 1624T* (CH1+2, dirty tone). In the mid 60's , vintage 1624T amps have been sought-after for decades because the Dual-Tone's volume knob is turned beyond noon, a fat and compressed clean tone evolves into an immediately recognizable grind* that remains articulate and listenable even when turned up to full blast.	Gain 1/2: Controls the effect gain amount Tone 1/2: Controls the effect tone Volume: Controls the effect output and gain amount

\*The manufacturers and product names mentioned above are trademarks or registered trademarks of their respective owners. The trademarks were used merely to identify the sound character of the products

## Effect List

AMP			
FX Title	Type	Description	Parameter Description
Foxy 15TB	Clean	Based on vintage VOX® AC-100* bass amp. In 1963, the Beatles was in urgent need of a bass speaker with a volume greater than that of the club's crazy shouting, and the AC-100* came into being. With 100W power and 4x12" box, it has successfully become the most representative bass voice in the 1960s.	Gain: Controls the effect gain amount Tone cut: Counterclockwise controls the effect tone Volume: Controls the effect output and gain amount Bass/Treble: 2-band EQ that controls the effect tone
Foxy 30N	Clean	Based on VOX® AC30HW* (normal channel). The symbolic clear sound and warm and sharp overdrive, since the day of its birth, has become the Shadows, The Beatles, the Rolling Stones and other group's favorite speaker. The British band led the "British Invasion" has made VOX® speaker a household name as a British rock icon. Even in hard rock and British rock, Radiohead, Suede, Oasis and other super groups are preferred.	Gain: Controls the gain amount (pre gain) Tone cut: Counterclockwise controls the effect tone Volume: Controls the output volume (post gain) Bright: Switches extra brightness on/off
Foxy 30TB	Drive	Based on VOX® AC30HW* (normal channel).	Gain: Controls the gain amount (pre gain) Tone cut: Counterclockwise controls the effect tone Volume: Controls the output volume (post gain) Bass/Treble: 2-band EQ that controls the effect tone Char: Selects from two sound characters: Cool (lower gain)/Hot (higher gain)
J-120 CL	Clean	Based on the legendary "Jazz Chorus" solid state combo. When it came out in 1975, it is the first musical instrument speaker equipped with Chorus effect. It was famous for its pure sound and stereo chorus effect.	Gain: Controls the effect gain/output amount Bright: Switches extra presence on/off Bass/Middle/Treble: 3-band EQ that controls the effect tone
Match CL	Clean	Based Matchless™ Chieftain 212 combo* (clean tone). MATCHLESS®'s philosophy since its founding in 1989 has been to make as many top-notch, all-purpose speakers as possible. The crisp graininess and perfect dynamic feedback will make your playing easy.	Gain: Controls the gain amount (pre gain) Presence: Controls the effect headroom Volume: Controls the output volume (post gain) Bass/Middle/Treble: 3-band EQ that controls the effect tone
Match OD	Drive	Based Matchless™ Chieftain 212 combo* (overdrive tone).	
L-Star CL	Clean	Based on Mesa/Boogie® Lone Star™*(CH1). The preamp circuit has extraordinary expressive power, the comprehensive timbre and intuitive operation are indicative of Mesa/Boogie®'s far superior technical capabilities. An engaging and lively timbre experience. It has a more compressed, balanced, soft mid frequency sound, and its high-frequency like gorgeous bell.	

\*The manufacturers and product names mentioned above are trademarks or registered trademarks of their respective owners. The trademarks were used merely to identify the sound character of the products

## Effect List

AMP			
FX Title	Type	Description	Parameter Description
L-Star OD	Drive	Based on Mesa/Boogie® Lone Star™(CH2).	Input: Controls the gain amount (pre gain) Gain: Controls the effect drive amount Presence: Controls the effect headroom Volume: Controls the output volume (post gain) Bass/Middle/Treble: 3-band EQ that controls the effect tone
BogSV CL	Clean	Based on Bogner ® Shiva* (20th Anniversary version, Ch1. Modern optimized circuit, with a double channel treasure house of sound, excellent circuit design makes it have high-frequency transparent and flexible low frequency, crystal clear sound, British higain compact and gorgeous.	Gain: Controls the gain amount (pre gain) Presence: Controls the effect headroom Volume: Controls the output volume (post gain) Bass/Treble: 2-band EQ that controls the effect tone Bright: Switches extra brightness on/off
BogSV OD	Drive	Based on Bogner ® Shiva* (20th Anniversary version, Ch2.	Gain: Controls the gain amount (pre gain) Presence: Controls the effect headroom Volume: Controls the output volume (post gain) Bass/Middle/Treble: 3-band EQ that controls the effect tone
Bog BlueV	Drive	Bogner® XTC blue channel is popular for its highly recognizable classic rock and roll sound. Its loud and handsome plexi voice has extraordinary attainments.	
Bog BlueM	Drive	Bogner® XTC blue channel is popular for its highly recognizable classic rock and roll sound. Its loud and handsome plexi voice has extraordinary attainments.	
Bog RedV	Hi Gain	The Bogner® XTC red channel is known for its fiery high gain distortion and the main timbre.	
Bog RedM	Hi Gain	The Bogner® XTC red channel is known for its fiery high gain distortion and the main timbre.	
Z38 CL	Clean	Based on Dr. Z® Maz 38 Sr.* combo (clean sound). With its varied sound, wide frequency response and dynamic range, it is not only an excellent single platform, but it can meet your needs whether you are a British or An American fan.	Gain: Controls the output volume (pre gain) Tone cut: Counterclockwise controls the effect tone Volume: Controls the output volume (post gain) Bass/Middle/Treble: 3-band EQ that controls the effect tone
Z38 OD	Drive	Based on Dr. Z® Maz 38 Sr.* combo (clean sound).	
Knights CL	Clean	Based on Grindrod® Pendragon PG20C* (Normal channel, bright off). If you're a big fan of British sound/overdrive, this is a sound you can't miss.It can bring the pure British style, sound full of penetrating power.	Gain: Controls the gain amount (pre gain) Volume: Controls the effect output (post gain) Bass/Middle/Treble: 3-band EQ that controls the effect tone
Knights CL+	Clean	Based on Grindrod® Pendragon PG20C* (Normal channel, bright on). If you're a big fan of British sound/overdrive, this is a sound you can't miss.It can bring the pure British style, sound full of penetrating power.	
Knights OD	Drive	Based on Grindrod® Pendragon PG20C* (Drive channel). If you're a big fan of British sound/overdrive, this is a sound you can't miss.It can bring the pure British style, sound full of penetrating power.	

\*The manufacturers and product names mentioned above are trademarks or registered trademarks of their respective owners.  
The trademarks were used merely to identify the sound character of the products

## Effect List

AMP			
FX Title	Type	Description	Parameter Description
Bad-KT CL	Clean	Based on Bad Cat® Hot Cat 30* (clean channel). As the world's first use of Class A circuit design guitar speakers, the sound quality has been greatly improved. It combines British and American styles, with rich harmonics and sufficient headroom.	Gain: Controls the gain amount (pre gain) Presence: Controls the effect headroom Volume: Controls the output volume (post gain)
Bad-KT OD	Drive	Based on Bad Cat® Hot Cat 30* (overdrive channel).	Gain: Controls the gain amount (pre gain) Presence: Controls the effect headroom Volume: Controls the output volume (post gain) Edge: Controls the high and high-mid tone character Bass/Treble: 2-band EQ that controls the effect tone
Solo100 CL	Clean	Based on Soldano® SLO100* (clean channel). Also from Eddie Van Halen's Brown Sound, Steve Vai's classic album "Passion & Warfare" was recorded in SLO100*.	Gain: Controls the gain amount (pre gain) Presence: Controls the effect headroom Volume: Controls the output volume (post gain) Bass/Middle/Treble: 3-band EQ that controls the effect tone
Solo100 OD	Drive	Based on Soldano® SLO100* (crunch channel).	
Solo100 LD	Hi Gain	Based on Soldano® SLO100* (overdrive channel). Also from Eddie Van Hale's Brown Sound, Steve Vai's classic album "Passion & Warfare" was recorded in SLO100*.	
		Famous users: Steve Vai, Mark Knopfler, Eric Clapton, Gary Moore	
UK 45	Drive	Based on Marshall® JTM45* (normal channel). In 1962, Marshall® introduced the first guitar speakers specifically designed for rock music, and its powerful sound laid the foundation for rock music. So its panel material plexiglas as the most classic 1960s sound specific name--- Plexi.	
UK 45+	Drive	Based on Marshall® JTM45* . In 1962, Marshall® introduced the first guitar speakers specifically designed for rock music, and its powerful sound laid the foundation for rock music. So its panel material plexiglas as the most classic 1960s sound specific name--- Plexi.	
UK 45JP	Drive	Based on Marshall® JTM45* . In 1962, Marshall® introduced the first guitar speakers specifically designed for rock music, and its powerful sound laid the foundation for rock music. So its panel material plexiglas as the most classic 1960s sound specific name--- Plexi.	Gain 1/2: Controls the gain amount (pre gain) Presence: Controls the effect headroom Volume: Controls the output volume (post gain) Bass/Middle/Treble: 3-band EQ that controls the effect tone

\*The manufacturers and product names mentioned above are trademarks or registered trademarks of their respective owners. The trademarks were used merely to identify the sound character of the products

## Effect List

AMP			
FX Title	Type	Description	Parameter Description
UK 50	Drive	Based on Marshall® JMP50* ("Jump" connection). Through the adjustment of JTM45*'s rectifier tube, the power was improved. In 1966, Marshall company launched JTM50*, and the "Plexi" sound obtained utilizing the overdrive by more people. The timbre is more full compared to JTM45*.	Gain: Controls the gain amount (pre gain) Presence: Controls the effect headroom Volume: Controls the output volume (post gain) Bass/Middle/Treble: 3-band EQ that controls the effect tone
UK 50+	Drive	Based on Marshall® JMP50* ("Jump" connection). Through the adjustment of JTM45*'s rectifier tube, the power was improved. In 1966, Marshall company launched JTM50*, and the "Plexi" sound obtained utilizing the overdrive by more people. The timbre is more full compared to JTM45*.	
UK 50JP	Drive	Based on Marshall® JMP50* ("Jump" connection). Through the adjustment of JTM45*'s rectifier tube, the power was improved. In 1966, Marshall company launched JTM50*, and the "Plexi" sound obtained utilizing the overdrive by more people. The timbre is more full compared to JTM45*.	Gain 1/2: Controls the gain amount (pre gain) Presence: Controls the effect headroom Volume: Controls the output volume (post gain) Bass/Middle/Treble: 3-band EQ that controls the effect tone
UK SLP	Drive	The 1959HWTM is a line right back to the celebrated era of the mid to late 1960s, the original was born when Pete Townshend asked Jim Marshall if he could make it louder. This re-issue delivers that classic Marshall tone with the same overdrive and crunch, using the authentic parts and methods to construct.	
UK 800	Drive	Based on Marshall® JCM800*. In 1981, the JCM800* quickly became the rock and metal sound of the '80s with its excellent high gain sound. The founders named it after their own license plate number, inheriting and continuing the legend of Plexi*.	Gain: Controls the gain amount (pre gain) Presence: Controls the effect headroom Volume: Controls the output volume (post gain) Bass/Middle/Treble: 3-band EQ that controls the effect tone
		Famous users: Kerry King, AC/DC, Zakk Wylde	
UK 900	Hi Gain	The JCM900 is the evolution of the JCM800® adding another channel, two reverb options and two gain features. Tube Set consists of 3 x 12AX7 preamp tubes, and 4 x 6L6/5881 power tubes. Known for its tone and workhorse roadworthiness, the JCM900 has many fans due to its feature set and versatility.	

\*The manufacturers and product names mentioned above are trademarks or registered trademarks of their respective owners. The trademarks were used merely to identify the sound character of the products

## Effect List

AMP			
FX Title	Type	Description	Parameter Description
Flagman 1	Drive	Based on the famous "Brown Eye" UK-style boutique amp head (BE channel). Improvement on Marshall® Plexi* basis. It has smooth high frequency, tight low frequency and high frequency gain function. It can be used in many musical styles.	Gain: Controls the gain amount (pre gain) Presence: Controls the effect headroom Volume: Controls the output volume (post gain) Bass/Middle/Treble: 3-band EQ that controls the effect tone
Flagman 2	Drive	Based on the famous "Brown Eye" UK-style boutique amp head (BE channel).	
Flagman+ 1	Hi Gain	Based on the famous "Brown Eye" UK-style boutique amp head (HBE channel).	
Flagman+ 2	Hi Gain	Based on the famous "Brown Eye" UK-style boutique amp head (HBE channel).	
Mess2C+ 1	Drive	Based on Mesa/Boogie® Mark II C+™ (Lead channel) with 2 different onboard switch combinations. In the 1980s, Mark II C + *established the position of Mesa / Boogie® metal style, and its voice appeared in the albums of Metallica and Dream Theater, and become a classic of American Higain.	Gain: Controls the gain amount (pre gain) Presence: Controls the effect headroom Volume: Controls the output volume (post gain) Bass/Middle/Treble: 3-band EQ that controls the effect tone
Mess2C+ 2	Drive		
Mess 2C+ 3	Drive		
Mess4 LD	Hi Gain	Based on Mesa/Boogie® Mark IV™ (Lead channel). Based on the classic upgrade, it inherits the omnipotence of Mesa / Boogie®, with rich harmonics and sustain from the voiceless tone to the sharp dark morden higain timbre.	
Mess4 LD 2	Hi Gain	Based on Mesa/Boogie® Mark IV™ (Lead 2 channel).	
Mess4 LD 3	Hi Gain	Based on Mesa/Boogie® Mark IV™ (Lead 3 channel).	
Mess DualV	Hi Gain	Based on Mesa/Boogie® Dual Rectifier® (Vintage mode). The distortion of Rectifier® series is warm, and the distortion of Rectifier® series is very wide, which is more thick and solid than Mark®.	
Mess DualM	Hi Gain	Based on Mesa/Boogie® Dual Rectifier® (Modern mode). The distortion of Rectifier® series is warm, and the distortion of Rectifier® series is very wide, which is more thick and solid than Mark®.	

\*The manufacturers and product names mentioned above are trademarks or registered trademarks of their respective owners. The trademarks were used merely to identify the sound character of the products

## Effect List

AMP			
FX Title	Type	Description	Parameter Description
Juice30 OD	Drive	Based on Orange® AD30™* (Dirty channel). This is an amp head with pure tube sound in the classic Class A circuit (with 4 E184 amp tubes), which guarantees harmonious sounds with an impressive spectrum. The "TC" stands for "twin channel", where a lead channel available, ensuring sustain rich sounds even at lowest volume.	Gain: Controls the gain amount (pre gain) Volume: Controls the output volume (post gain) Bass/Middle/Treble: 3-band EQ that controls the effect tone
Juice R100	Hi Gain	Based on Orange® Rockerverb 100™* (Dirty channel). Once launched, this amplifier has become a new favorite of rock musicians. Its sound is unique, and its timbre can be controlled from warm and sweet clear tone to heavy music, which will bring surprise to the performers.	
EV 51	Hi Gain	Based on Peavey® 5150® (LEAD channel). Guitarist Eddie Van Halen, who began working with Peavey® in the 1980s, loved the sound and took the album's title "5150" to the world with its metallic sound.	Gain: Controls the gain amount (pre gain) Volume: Controls the output volume (post gain) Bass/Middle/Treble: 3-band EQ that controls the effect tone Presence: Controls the effect headroom
		Famous users: Eddie Van Halen	
Eagle 120	Hi Gain	ENGL® Savage 120 Amplifier embodies ENGL's rich legacy of creating metal machines for delivering truly punishing tones, with clear dynamics and tremendous sonic variety. This incredible tonal flexibility comes from the 4 channel layout of the amp, with a dedicated Clean channel, two separate Crunch channels, and a super-saturated Lead channel, all supported by two discrete EQs and a wide selection of additional features.	Gain: Controls the gain amount (pre gain) Presence: Controls the effect headroom Volume: Controls the output volume (post gain) Bass/Middle/Treble: 3-band EQ that controls the effect tone
Eagle 120+	Hi Gain		
Power LD	Hi Gain	Based on ENGL® Powerball II E645/2* (CH4). It can bring you extremely compact low frequency, a lot of gain and precise dynamic response, which is very suitable for modern rock and metal music.	

\*The manufacturers and product names mentioned above are trademarks or registered trademarks of their respective owners.  
The trademarks were used merely to identify the sound character of the products

## Effect List

AMP			
FX Title	Type	Description	Parameter Description
Dizz VH	Hi Gain	Based on Diezel® Vh4*. Born in Germany in the 1990s, its timbre and multifunction have attracted countless guitar masters. The unique Modern Higain quickly conquered many musicians.  Famous users: Guns N' Roses, METALLICA, KORN, Slipknot, BON JOVI	Gain: Controls the gain amount (pre gain) Presence: Controls the effect headroom Volume: Controls the output volume (post gain) Bass/Middle/Treble: 3-band EQ that controls the effect tone
Dizz VH S			
Dizz VH+			
Dizz VH+ S			
Classic Bass	Bass	Based on Ampeg® SVT* bass amp. Launched in 1969, Ampeg SVT has always been the most mainstream bass speaker, Have a strong ability to sound shape.	Gain: Controls the gain amount Midrange: Selects the center frequency of Midrange control: 220Hz/450Hz /800Hz/1.6kHz/3kHz Bass/Middle/Treble: 3-band EQ that controls the effect tone Volume: Controls the output volume (post gain)
Foxy Bass	Bass	Based on vintage VOX® AC-100* bass amp. In 1963, the Beatles was in urgent need of a bass speaker with a volume greater than that of the club's crazy shouting, and the AC-100* came into being. With 100W power and 4x12 "box, it has successfully become the most representative bass voice in the 1960s.	Volume: Controls the effect gain/output amount Bass/Treble: 2-band EQ that controls the effect tone
Mess Bass	Bass	Based on Mesa/Boogie® Bass 400* amp. You can hear the sound of the early bass speakers in many albums.	Gain: Controls the gain amount Volume: Controls the output volume (post gain) Bass/Middle/Treble: 3-band EQ that controls the effect tone
Mini Bass	Bass	Based on Ampeg® B-15* "Flip Top" bass amp. The B-15* was conceived by legendary Jess Oliver in 1958. It can be seen from the early clubs to the world's top studios. B-15* can be said to be a landmark product that is hard to be ignored.	Volume: Controls the effect gain/output amount Bass/Treble: 2-band EQ that controls the effect tone
Bass Pre	Bass	Based on Alembic™ F-2B* preamp. In the 1960s, inspired by the Fender® speaker, the circuit was transformed in an all-round way, which brought the extremely advanced adjustment mode at that time, which was loved by many musicians, thus leaving a strong mark in the history of rock music.	Volume: Controls the effect gain/output amount Bright: Switches extra brightness on/off Bass/Middle/Treble: 3-band EQ that controls the effect tone

\*The manufacturers and product names mentioned above are trademarks or registered trademarks of their respective owners. The trademarks were used merely to identify the sound character of the products

## Effect List

AMP			
FX Title	Type	Description	Parameter Description
AC Pre	Acoustic	Based on AER® Colourizer 2* acoustic preamp. Originated in Germany, it is a preamp designed for acoustic guitar sound reinforcement. It will bring richer dynamics and overtones to your acoustic guitar, making the sound more three-dimensional and vivid.	<p>Volume: Controls the effect gain/output amount</p> <p>Tone: Controls the brightness</p> <p>Balance: Controls the tone control balance; set to 0 to disable tone control</p> <p>EQ Freq: Controls the EQ center frequency from 90Hz to 1.6kHz</p> <p>EQ Q: Controls the EQ bandwidth</p> <p>EQ Gain: Controls the EQ boost/cut amount; set to 50 to keep neutral</p>
AC Pre 2	Acoustic	Based on AER® Colourizer 2* acoustic preamp. Originated in Germany, it is a preamp designed for acoustic guitar sound reinforcement. It will bring richer dynamics and overtones to your acoustic guitar, making the sound more three-dimensional and vivid.	<p>Volume: Controls the effect gain/output amount</p> <p>Tone: Controls the brightness</p> <p>Balance: Controls the tone control balance; set to 0 to disable tone control</p> <p>EQ Freq: Controls the EQ center frequency from 680Hz to 11kHz</p> <p>EQ Q: Controls the EQ bandwidth</p> <p>EQ Gain: Controls the EQ boost/cut amount; set to 50 to keep neutral</p>

NR			
FX Title	Type	Description	Parameter Description
Gate 1	Gate	Based on famous ISP®Decimator™* noise gate pedal. The Decimator features improvements in the expander tracking with their new Linearized Time Vector Processing™. This novel improvement provides a more linear release time-constant response for the exponential release curve of the downward expander.	Threshold: Controls the gate trigger level
Gate 2	Gate	Flexible noise gate with attack and release control.	<p>Threshold: Controls the gate trigger level</p> <p>Attack: Controls how soon the gate starts to process the signal</p> <p>Release: Controls the noise fade-out duration time after the level drops below the threshold</p>

\*The manufacturers and product names mentioned above are trademarks or registered trademarks of their respective owners. The trademarks were used merely to identify the sound character of the products

# Effect List

CAB			
FX Title	Type	Description	Parameter Description
SUP ZEP	1 x 6"	Supro®* 1x6" cabinet with oval speaker	Volume: Controls effect output volume Low Cut: Highpass filter, cut off the low-frequency signal below the selected Hi Cut: Lowpass filter, cut off the high-frequency signal above the selected
TWD CP	1 x 8"	Vintage Fender® Champ* 1x8" cabinet	
TWD PRC	1 x 10"	Vintage Fender® Princeton* 1x10" cabinet	
TWD SUP	2 x 10"	A custom Fender® Tweed* 2x10" cabinet	
TWD LUX	1 x 12"	Fender® Tweed Deluxe* 1x12" cabinet	
Dark LUX	1 x 12"	Vintage Fender® Deluxe* 1x12" cabinet	
Dark VIT	1 x 12"	Vintage Fender® Vibrolux* 1x12" cabinet	
Dark Twin	2 x 12"	Vintage Fender® '65 Twin Reverb* 2x12" cabinet	
Dark CS	2 x 12"	Custom modified Fender®* 2x12" cabinet	
Bellman 1	2 x 12"	Vintage Fender® "Piggyback" Bassman®* 2x12" cabinet	
Bellman 2	4 x 10"	Fender® '59 Bassman®* 4x10" cabinet	
J-120	2 x 12"	Legendary "Jazz Chorus" 2x12" cabinet	
UK G12	1 x 12"	Marshall®* 1x12" cabinet	
UK GRN 1	2 x 12"	Marshall® 2550* 2x12" cabinet	
UK LD	4 x 12"	Marshall® 1960AV* 4x12" cabinet	
UK TD	4 x 12"	68 Marshall® Basketweave* 4x12" cabinet	
UK MD	4 x 12"	Custom modified Marshall®* 4x12" cabinet	
UK GRN 2	4 x 12"	Vintage Marshall® 4x12" cabinet with Celestion® Greenback®* speakers	
UK 75	4 x 12"	Marshall®* 4x12" cabinet with Celestion® G12T-75* speakers	
UK Dark	4 x 12"	1968 Marshall®* 4x12" cabinet	
FOXY 1	1 x 12"	Vintage VOX® AC15* 1x12" cabinet	
FOXY 2	2 x 12"	Vintage VOX® AC30* 2x12" cabinet	
ROUT	1 x 12"	Carr® Rambler* 1x12" cabinet	
BogSV	1 x 12"	Bogner® Shiva* 1x12" cabinet	
Bad-KT	1 x 12"	Black Cat® Hot Cat* 1x12" cabinet	
Match	2 x 12"	Matchless® Chieftain* 2x12" cabinet	
TOM OPEN	1 x 12"	Swart® Atomic Space* 1x12" cabinet	
ACE	1 x 12"	Morgan® AC-20 Deluxe* 1x12" cabinet	
Mess	4 x 12"	Mesa/Boogie® Rectifier®* 4x12" cabinet	
D STAR	1 x 12"	Mesa/Boogie® Lonestar® 1x12" cabinet	
SUP Star	2 x 12"	Mesa/Boogie® Lonestar* 2x12" cabinet	
US STO	1 x 12"	1980's Mesa/Boogie®* 1x12" cabinet	
BOUTI	2 x 12"	A unique custom 2x12" cabinet	
SUP	2 x 12"	Supro® 1624T* 2x12" cabinet"	
MATT TWD	2 x 12"	Matchless®* 2x12" cabinet	
Freed	2 x 12"	Fryette® Deliverance* 2x12" cabinet	

\*The manufacturers and product names mentioned above are trademarks or registered trademarks of their respective owners. The trademarks were used merely to identify the sound character of the products

## Effect List

CAB			
FX Title	Type	Description	Parameter Description
DB Rock	2 x 12"	Two-Rock®* 2x12" cabinet	Volume: Controls effect output volume Low Cut: Highpass filter, cut off the low-frequency signal below the selected Hi Cut: Lowpass filter, cut off the high-frequency signal above the selected
Blue SK	2 x 12"	A custom 2x12" cabinet with Celestion® Alnico Blue* speakers	
EV	4 x 12"	Peavey® 6505* 4x12" cabinet	
Bog	4 x 12"	Bogner®* 4x12" cabinet	
Eagle	4 x 12"	ENGL®* 4x12" cabinet	
Uban	4 x 12"	Bogner® Uberkab* 4x12" cabinet	
Solo	4 x 12"	Soldano®* 4x12" cabinet	
Juice	4 x 12"	Orange® PPC412* 4x12" cabinet	
H-WAY	4 x 12"	Vintage Hiwatt® SE4123* 4x12" cabinet	
Way	4 x 12"	Vintage WEM®* 4x12" cabinet	
Dumb	4 x 12"	Dumble®* 4x12" cabinet	
Dizz	4 x 12"	Diezel®* 4x12" cabinet	
TRP	4 x 12"	Hughes & Kettner® Triamp* 4x12" cabinet	
King	4 x 12"	Mesa/Boogie® Road King®* 4x12" cabinet	
ADM 1	1 x 15"	David Eden®* 1x15" bass cabinet	
ADM 2	4 x 10"	David Eden®* 4x10" bass cabinet	
Workman 1	1 x 15"	SWR®* 1x15" bass cabinet	
Workman 2	4 x 10"	SWR® Workingman's* 4x10" bass cabinet	
US BASS	2 x 10"	Mesa/Boogie®* 2x10" bass cabinet	
MATT	2 x 10"	Mark Bass®* 2x10" bass cabinet	
F-TOP	1 x 15"	Ampeg® PF-115HE* 1x15" bass cabinet	
AMPG 1	4 x 10"	Ampeg® SVT-410HE* 4x10" bass cabinet	
AMPG 2	8 x 10"	Ampeg SVT-810E* 8x10" bass cabinet	
HACK	4 x 12"	Hartke®* 4x12" bass cabinet	
AC	Acoustic	Dreadnought guitar simulation 1	
AC Dream	Acoustic	Dreadnought guitar simulation 2	
OM	Acoustic	Simulates an OM type acoustic guitar	
JUMBO	Acoustic	Simulates a jumbo acoustic guitar	
Bird	Acoustic	Simulates the iconic "H-Bird" acoustic guitar	
GA	Acoustic	Simulates a GA type acoustic guitar	
Classic AC	Acoustic	Simulates a classical guitar	
Mandolin	Acoustic	Simulates a mandolon	
Fretless Bass	Acoustic	Simulates a fretless acoustic bass	
Double Bass	Acoustic	Simulates a double bass	
User IR 1~20		User IR 1~20 IR WAV (44kHz/1024 sample rate)	

\*The manufacturers and product names mentioned above are trademarks or registered trademarks of their respective owners. The trademarks were used merely to identify the sound character of the products.

## Effect List

EQ			
FX Title	Type	Description	Parameter Description
Guitar EQ 1	EQ	Equalizer designed for guitars	Band 1: 125Hz; Band 2: 400Hz ; Band 3: 800Hz; Band 4: 1.6kHz; Band 5: 4kHz Use the five bands above to control the EQ level. Volume: Controls the output level
Guitar EQ 2			Band 1: 100Hz; Band 2: 500Hz ; Band 3: 1kHz; Band 4: 3kHz; Band 5: 6kHz Use the five bands above to control the EQ level. Volume: Controls the output level
Bass EQ 1	EQ	Equalizer designed for basses	Band 1: 33Hz; Band 2: 150Hz ; Band 3: 600Hz; Band 4: 2kHz; Band 5: 8kHz Use the five bands above to control the EQ level. Volume: Controls the output level
Bass EQ 2			Band 1: 50Hz; Band 2: 120Hz ; Band 3: 400Hz; Band 4: 800Hz; Band 5: 4.5kHz Use the five bands above to control the EQ level. Volume: Controls the output level
Mess EQ	EQ	Based on the 5-band EQ module on Mesa/Boogie®* amps, can easily realize the classic boogie V-shaped sound	Band 1: 80Hz; Band 2: 240Hz ; Band 3: 750Hz; Band 4: 2.2kHz; Band 5: 6.6kHz Use the five bands above to control the EQ level.
Hyper EQ	EQ	10-band graphic EQ suitable for any instrument	Band 1: 31Hz; Band 2: 63Hz ; Band 3: 125Hz; Band 4: 250Hz; Band 5: 500Hz; Band 6: 1kHz; Band 7: 2kHz; Band 8: 4kHz; Band 9: 8kHz Band 10: 16kHz Use the ten bands above to control the EQ level. Volume: Controls the output level

MOD			
FX Title	Type	Description	Parameter Description
G-Chorus	Chorus	Based on the legendary huge ensemble chorus pedal born in late 1970s (chorus mode), producing rich, shimmering vintage analog chorus tone. Warm, rich, and dreamlike analog chorus sound.	Depth: Controls the chorus depth Rate: Controls the chorus rate Volume: Controls the effect level Sync: Switches Tap Tempo sync on/off

\*The manufacturers and product names mentioned above are trademarks or registered trademarks of their respective owners. The trademarks were used merely to identify the sound character of the products

# Effect List

MOD			
FX Title	Type	Description	Parameter Description
C-Chorus	Chorus	Based on a legendary 4-button purple stereo chorus pedal, providing detailed rich chorus tone that expands sonic dimensions	Mode: Select from 4 different chorus modes
B-Chorus	Chorus	Based on the famous ensemble chorus unit tuned for bassists	Depth: Controls the vibrato depth Rate: Controls the vibrato rate Volume: Controls the effect level Sync: Switches Tap Tempo sync on/off
M-Chorus	Chorus	A multi-dimensional chorus pedal producing rich surrounding chorus sound, better playing with stereo sound systems	Mix: Controls the wet/dry signal ratio Rate: Controls the chorus speed Filter: Controls the effect tone Depth L/C/R: Controls the chorus depth of left/right/center channels Sync: Switches Tap Tempo sync on/off
Jet	Flanger	Classic flanger effect, producing rich and natural flanger tone.	Depth: Controls the flanger depth Rate: Controls the flanger speed Pre Delay: Controls the pre delay time Feedback: Controls the amount of feedback Sync: Switches Tap Tempo sync on/off
B-Jet	Flanger	Classic flanging effect tuned for basses	
N-Jet	Flanger	A flanger with negative feedback, producing "underwater" style sound	
Trem Jet	Flanger	Combines flanger and tremolo in one	Flg Depth: Controls the flanger depth Flg Rate: Controls the flanger speed Feedback: Controls the flanger feedback amount Trm Depth: Controls the tremolo depth Trm Rate: Controls the tremolo speed Flg Sync: Switches flanger Tap Tempo sync on/off Trm Sync: Switches tremolo Tap Tempo sync on/off
V-Roto	Vibrato	Based on a BBD-based blue vibrato pedal, producing natural analog vibrato sound	Depth: Controls the vibrato depth Rate: Controls the vibrato rate Sync: Switches Tap Tempo sync on/off
G-Roto	Vibrato	Based on the legendary huge ensemble chorus pedal born in late 1970s (vibrato mode), producing rich, shimmering vintage analog vibrato tone	Depth: Controls the vibrato depth Rate: Controls the vibrato rate Volume: Controls the effect output Sync: Switches Tap Tempo sync on/off
Vibrato	Vibrato	A classic vibrato effect with wide adjustable range	Depth: Controls the vibrato depth Rate: Controls the vibrato speed Volume: Controls the effect level Sync: Switches Tap Tempo sync on/off
O-Phase	Phaser	Based on legendary MXR® M101 Phase 90*. Have you heard the guitar sound in Eddie Van Halen's "Eruption". That distorted tone with a sense of rotation is realized by Phase 90.	Rate: Controls the vibrato speed Sync: Switches Tap Tempo sync on/off

\*The manufacturers and product names mentioned above are trademarks or registered trademarks of their respective owners. The trademarks were used merely to identify the sound character of the products

# Effect List

MOD			
FX Title	Type	Description	Parameter Description
G-Phase	Phaser	Based on a BBD-based green phase pedal, producing natural analog phase sound	Depth: Controls the phaser depth Rate: Controls the phaser speed Sync: Switches Tap Tempo sync on/off
S-Phase	Phaser	The Electro Harmonix Small Stone was one of the first phasers available in the 70's and can be heard on countless recordings. As the competitors of that time, it comes with a control (rate, the speed of the effect) and the intensity can be modified with a switch - the sound is just right for most applications.	Color: Selects from two sound characters: Warm/Sharp Rate: Controls the phaser speed Sync: Switches Tap Tempo sync on/off
Pan Phase	Phaser	A special, subtle phaser combines tremolo/pan variations	Phs Depth: Controls the phaser depth Phs Rate: Controls the phaser speed Pan Depth: Controls the tremolo depth (using mono output) or panning depth (using stereo output) Pan Rate: Controls the tremolo speed (using mono output) or panning speed (using stereo output) Phs Sync: Switches phaser Tap Tempo sync on/off Pan Sync: Switches tremolo/pan Tap Tempo sync on/off
M-Vibe	Phaser	Based on Voodoo Lab® Micro Vibe*. Voodoo Lab Micro Vibe has the same design as the original 1968 Uni-Vibe*. Jimi Hendrix and Stevie Ray Vaughan used these effects extensively in their albums. The Vibe effect will bring about slight and regular pitch changes.	Depth: Controls the effect depth Rate: Controls the effect speed Sync: Switches Tap Tempo sync on/off
Vibe	Phaser	The Shin-Ei Uni-Vibe is a classic phase shifter(chorus) effect made famous by Jimi Hendrix, David Gilmour, Robin Trower and many more. The rich "chorus" effect that it's famous for has become a staple in a classic rock guitarist's rig. While the Uni-Vibe's construction is closely copied by many companies, many players confirm that there's just nothing like the real thing!	Depth: Controls the effect depth Rate: Controls the effect speed Volume: Controls the effect output Mode: Select from 2 different vibe modes: Chorus and Vibrato Sync: Switches Tap Tempo sync on/off
O-Trem	Tremolo	Based on legendary Demeter® TRM-1Tremulator*, offering classical opto tremolo sound. In 1982, rock pioneer Ry Cooder approached James Demeter to ask whether the tremolo sound of the Fender® twin series speakers could be made into a pedal effect device, and this classic effect device was born.	Depth: Controls the tremolo depth Rate: Controls the tremolo speed Sync: Switches Tap Tempo sync on/off
Sine Trem	Tremolo	Sine tremolo waveforms and super wide tonal range.	Depth: Controls the effect depth Rate: Controls the effect speed
Triangle Trem	Tremolo	Triangle tremolo waveforms and super wide tonal range.	Volume: Controls the effect output Sync: Switches Tap Tempo sync on/off

\*The manufacturers and product names mentioned above are trademarks or registered trademarks of their respective owners. The trademarks were used merely to identify the sound character of the products

## Effect List

MOD			
FX Title	Type	Description	Parameter Description
Bias Trem	Tremolo	Bias tremolo waveforms and super wide tonal range	Depth: Controls the effect depth Rate: Controls the effect speed Volume: Controls the effect output Sync: Switches Tap Tempo sync on/off Bias: Adjust the offset change of the waveform
Detune	Pitch	This is a detuning effect that combines a slightly shifted signal with the original signal to create a chorus-like tone.	Detune: Detune: Controls the detune amount from -50 to +50 cents Dry/Wet: Controls the dry/wet signal level
Bit Smash	Special	Provides bitcrushing/sample reducing effect with musical fashion	Mix: Controls the wet/dry signal ratio of the effect Krush: Controls the sample rate of the effect Bit: Controls the bit resolution of the effect Hi Cut: Controls the cutoff frequency of the high cut filter Lo Cut: Controls the cutoff frequency of the low cut filter
Auto Swell	Special	This is an auto swell effect with two parameters that are easy to understand and use. It can make the guitar sound like a violin.	Attack: Controls how fast the effect swells the input signal Curve: Selects the volume swell curve (Line, Exp, Log)

DLY			
FX Title	Type	Description	Parameter Description
BBD Delay S	Delay	This is a stereo analog delay model that captures the sound of a BBD based analog delay machine that is warm, smooth, rounded due to the limitation of BBD chips.	Mix: Controls the wet/dry signal ratio Feedback: Controls the amount of feedback Time: Controls the delay time of left channel Time R%: Controls the delay time of right channel (time ratio of left channel)
Digital Delay S	Delay	This model is a stereo digital delay that produces a pure clean delay sound, clear and accurate.	Spread: Controls the effect stereo width Level: Controls the effect output Sync: Switches Tap Tempo sync on/off Trail: Switched effect trail on/off when the effect is bypassed
Tape Delay S	Delay	Back in the old days, producers and engineers created delay and echo effects using tape machines. That sweet, space-like echo tone is still popular today, especially among psychedelic musicians.	Mix: Controls the wet/dry signal ratio Feedback: Controls the amount of feedback Time: Controls the delay time of left channel Time R%: Controls the delay time of right channel (time ratio of left channel) Spread: Controls the effect stereo width Wow & Flutter: Controls the delay pitch/speed variation amount caused by malfunctioning tape/motor Age: Selects from 3 tone variations Spread: Controls the effect stereo width Scrape: Controls the tape scratch amount Drive: Controls the delay distortion amount Level: Controls the effect output Sync: Switches Tap Tempo sync on/off Trail: Switched effect trail on/off when the effect is byp

\*The manufacturers and product names mentioned above are trademarks or registered trademarks of their respective owners. The trademarks were used merely to identify the sound character of the products

# Effect List

DLY			
FX Title	Type	Description	Parameter Description
Ambience 1	Delay	This model is a multi-tap delay that brings you expanded sound spaciousness. 1, 2 stands for different tonal variations	Mix: Controls the wet/dry signal ratio Feedback: Controls the amount of feedback Time: Controls the delay time Level: Controls the effect output Mod: Controls the effect modulation amount Tone: Controls the effect tone Sync: Switches Tap Tempo sync on/off Trail: Switched effect trail on/off when the effect is bypassed
Ambience 2	Delay		
Pure	Delay	Produce pure, precised delay sound	Mix: Controls the wet/dry signal ratio Time: Controls the delay time Feedback: Controls the amount of feedback Sync: Switches Tap Tempo sync on/off Trail: Switched effect trail on/off when the effect is bypassed
Analog	Delay	Producing warm delay sound with analog feel	
Tape	Delay	Simulates solid-state tape echo sound	
Ping Pong	Delay	A ping-pong delay producing stereo feedback bounces back and forth between left and right channels	
Slapback	Delay	Simulates the classic slapback echo effect	Mix: Controls the delay wet/dry signal ratio Time: Controls the delay time Feedback: Controls the amount of feedback Trail: Switched effect trail on/off when the effect is bypassed
Sweep Echo	Delay	Producing a delay effect with sweeping filter modulated repeats	Mix: Controls the wet/dry signal ratio Time: Controls the delay time Feedback: Controls the amount of feedback Sweep Depth: Controls the sweep filter depth Sweep Rate: Controls the sweep filter speed Sweep Sync: Switches sweep filter Tap Tempo sync on/off Time Sync: Switches delay Tap Tempo sync on/off Trail: Switched effect trail on/off when the effect is bypassed
Ring Echo	Delay	Producing a delay effect with ring modulated repeats	Dly Mix: Controls the delay wet/dry signal ratio Time: Controls the delay time Feedback: Controls the amount of feedback Ring Mix: Controls the ring mod wet/dry signal ratio Freq: Controls the ring mod frequency Tone: Controls the ring mod tone Sync: Switches Tap Tempo sync on/off Trail: Switched effect trail on/off when the effect is bypassed
Tube	Delay	Simulates tube-driven tape echo sound	Mix: Controls the wet/dry signal ratio Time: Controls the delay time Feedback: Controls the amount of feedback Sync: Switches Tap Tempo sync on/off Trail: Switched effect trail on/off when the effect is bypassed

\*The manufacturers and product names mentioned above are trademarks or registered trademarks of their respective owners.  
The trademarks were used merely to identify the sound character of the products

## Effect List

DLY			
FX Title	Type	Description	Parameter Description
M-Echo	Delay	A multi tap delay that simulates a huge 4-head tape echo machine	Mix: Controls the wet/dry signal ratio Time: Controls the delay time Feedback: Controls the amount of feedback Tone: Controls the effect tone Mode: Selects from 12 different head variations Sync: Switches delay Tap Tempo sync on/off Trail: Switched effect trail on/off when the effect is bypassed
Sweet Echo	Delay	This analog delay pedal was sold from 1981 to 1984 and is still sought after thanks to its warm, natural sound. Produces a delay time ranging from 20 to 300 milliseconds.	Mix: Controls the wet/dry signal ratio Time: Controls the delay time Feedback: Controls the amount of feedback Sync: Switches Tap Tempo sync on/off Trail: Switched effect trail on/off when the effect is bypassed
999 Echo	Delay	Based on Maxon® Ad900 Analog Delay*, providing warm, accurate delay sound. 100% Analog Delay, dynamic distortion on Delay repeats, gorgeous, warm, organic delay tone.  Famous users: Pink Floyd	
Vintage Rack	Delay	Reproduces the sound of a vintage 1980's rack-mount delay machine with slightly sample-reduced feedback	Mix: Controls the wet/dry signal ratio Time: Controls the delay time Feedback: Controls the amount of feedback Mod: Controls the effect modulation amount Tone: Controls the effect tone Sync: Switches Tap Tempo sync on/off Trail: Switched effect trail on/off when the effect is bypassed
Lofi Echo	Delay	Producing a delay effect with lo-fi'd repeats	
Rev Echo	Delay	Producing a special delay effect with reversed feedback	Mix: Controls the wet/dry signal ratio Time: Controls the delay time Feedback: Controls the amount of feedback Level: Controls the effect output volume Sync: Switches Tap Tempo sync on/off Trail: Switched effect trail on/off when the effect is bypassed

RVB			
FX Title	Type	Description	Parameter Description
Room	Reverb	Simulates the spaciousness of a room	Mix: Controls the wet/dry signal ratio Pre Delay: Controls the amount of time between the dry signal and the audible onset of early reflections and the reverb tail Decay: Controls the duration of reverb time Trail: Switched effect trail on/off when the effect is bypassed
Hall	Reverb	Simulates the spaciousness of a performance hall	
Church	Reverb	Simulates the spaciousness of a church	
Plate	Reverb	Simulates the sound character produced by a vintage plate reverberator	Mix: Controls the wet/dry signal ratio Decay: Controls the duration of reverb time High Damp: Controls the low pass filter frequency Trail: Switched effect trail on/off when the effect is bypassed

\*The manufacturers and product names mentioned above are trademarks or registered trademarks of their respective owners. The trademarks were used merely to identify the sound character of the products

# Effect List

RVB			
FX Title	Type	Description	Parameter Description
Spring	Reverb	Simulates the sound character produced by a vintage spring reverberator	Mix: Controls the wet/dry signal ratio Decay: Controls the duration of reverb time Tone: Controls the effect tone Trail: Switched effect trail on/off when the effect is bypassed
Studio	Reverb	This reverb model recreates the spaciousness of a recording studio.	Mix: Controls the wet/dry signal ratio Pre Delay: Controls the amount of time between the dry signal and the audible onset of early reflections and the reverb tail Decay: Controls the duration of reverb time Low Damp/Hi Damp: Dampens the effect low/high frequency amount Mod: Controls the effect modulation amount Trail: Switched effect trail on/off when the effect is bypassed
Club	Reverb	This reverb model recreates the spaciousness of a club.	
Concert	Reverb	This reverb model recreates the spaciousness of a concert hall.	
Arena	Reverb	This reverb model recreates the spaciousness of a live arena.	
N-Star	Reverb	Special-tuned reverb effect with lush, bright decays	Mix: Controls the wet/dry signal ratio Decay: Controls the duration of reverb time Trail: Switched effect trail on/off when the effect is bypassed
Deepsea	Reverb	Special-tuned reverb effect with huge, deep decays	Mix: Controls the wet/dry signal ratio Decay: Controls the duration of reverb time Trail: Switched effect trail on/off when the effect is bypassed
Sweet Space	Reverb	Produces a modulated reverb effect that is lush and sweet	Mix: Controls the wet/dry signal ratio Pre Delay: Controls the amount of time between the dry signal and the audible onset of early reflections and the reverb tail Decay: Controls the duration of reverb time Lo End: Controls the low frequency amount High End: Controls the high pass filter frequency Trail: Switched effect trail on/off when the effect is bypassed
Shimmer	Reverb	Produce a rich, shimmering reverb effect	

VOL			
FX Title	Type	Description	Parameter Description
Volume	Volume	Pure volume control	Volume: Controls output volume

\*The manufacturers and product names mentioned above are trademarks or registered trademarks of their respective owners. The trademarks were used merely to identify the sound character of the products

# Drum Rhythm List

Genre	Type	Time Signature	Default Tempo
Rock	Classic Rock 1	4/4	120BPM
	Classic Rock 2	4/4	
	Classic Rock 3	4/4	
	Classic Rock 4	4/4	
	Classic Rock 5	4/4	
	Classic Rock 6	4/4	
	Hard Rock 1	4/4	
	Hard Rock 2	4/4	
	Hard Rock 3	3/4	
	Post Rock 1	5/4	
	Post Rock 2	4/4	
	Post Rock 3	4/4	
	Garage Rock	4/4	
	Prog Rock	4/4	
	Surf Rock	4/4	
	Punk 1	4/4	
	Punk 2	4/4	
	Punk 3	4/4	
	Punk 4	4/4	
	Post Punk 1	4/4	
	Post Punk 2	4/4	
	Heavy Metal 1	4/4	
	Heavy Metal 2	4/4	
	Nu-Metal 1	4/4	
	Nu-Metal 2	4/4	
	Hardcore	4/4	
	EMO	4/4	
	Grunge	4/4	
New Wave	4/4		
Rock 5/4	5/4		
Funk	Funk 1	4/4	120BPM
	Funk 2	4/4	
	Funk 3	4/4	
	Funk 4	4/4	
	Jazz Funk 1	4/4	
	Jazz Funk 2	4/4	
	Jazz Funk 3	4/4	

# Drum Rhythm List

Genre	Type	Time Signature	Default Tempo
Blues	Blues 1	4/4	120BPM
	Blues 2	4/4	
	Blues 3	4/4	
	Blues 4	4/4	
	Swing	4/4	
	Shuffle	4/4	
	Shuffle 3/4	3/4	
	Bluegrass	4/4	
	Country	4/4	
	Country Folk	4/4	
Pop	Pop 1	4/4	
	Pop 2	4/4	
	Pop 3	4/4	
	Hip Hop 1	4/4	
	Hip Hop 2	4/4	
	Hip Hop 3	4/4	
	Hip Hop Rock	4/4	
	Pub	4/4	
Jazz	Jazz 1	4/4	
	Jazz 2	4/4	
	Jazz 3	4/4	
	Jazz 4	4/4	
	Bossanova 1	4/4	
	Bossanova 2	4/4	
	Fusion	4/4	
Electronic	Electro1	4/4	
	Electro2	4/4	
	Techno	4/4	
	TripHop	4/4	
	Electronic Pop	4/4	
	Break Beat	4/4	
	Drum & Bass	4/4	
World	Latin 1	4/4	
	Latin 2	4/4	
	Latin 3	4/4	
	Latin Pop 1	4/4	
	Latin Pop 2	4/4	

# Drum Rhythm List

Genre	Type	Time Signature	Default Tempo
World	Samba	4/4	120BPM
	Tango	4/4	
	Beguine	4/4	
	Ska	4/4	
	Polka	2/4	
	Waltz	3/4	
	Reggae 1	4/4	
	Reggae 2	4/4	
	Mazuke	3/4	
	Musette	4/4	
	March 1	4/4	
	March 2	4/4	
	March 3	4/4	
	New Age 1	4/4	
	New Age 2	4/4	
	World	4/4	
Metro	1/4	1/4	
	2/4	2/4	
	3/4	3/4	
	4/4	4/4	
	5/4	5/4	
	6/4	6/4	
	7/4	7/4	
	6/8	6/8	
	7/8	7/8	
	9/8	9/8	

## MIDI Control Information List

CC#	Value Range	Description
0	0-1	BANK MSB: 01-A~32-D: CCO=1, PC=0-127 33-A~64-D CCO=0, PC=0-127
7	0-99	Patch Volume
11	0-100	EXP 1
13	0-127	EXP1 A/B 0-63 A 64-127 B
16	0-100	Quick Access Para 1
17	0-127	Quick Access Knob 1 parameter adjustment: 0-63: Turn down by 1 step 64-127: Turn up by 1 step
18	0-127	Quick Access Knob 2
19	0-127	Quick Access Knob 2 parameter adjustment: 0-63: Turn down by 1 step 64-127: Turn up by 1 step
20	0-127	Quick Access Knob 3
21	0-127	Quick Access Knob 3 parameter adjustment: 0-63: Turn down by 1 step 64-127: Turn up by 1 step
22	0-127	BANK - (initial mode)
23	0-127	BANK + (initial mode)
24	0-127	Patch -
25	0-127	Patch +
26	0-127	BANK - (wait mode)
27	0-127	BANK +(wait mode)
28	0-127	BANK (wait mode)
48	0-127	PRE Module on/off: 0-63: off 64-127: on
49	0-127	DST Module on/off: 0-63: off 64-127: on

CC#	Value Range	Description
50	0-127	AMP Module on/off: 0-63: off 64-127: on
51	0-127	NR Module on/off: 0-63: off 64-127: on
52	0-127	CAB Module on/off: 0-63: off 64-127: on
53	0-127	EQ Module on/off: 0-63: off 64-127: on
54	0-127	MOD Module on/off: 0-63: off 64-127: on
55	0-127	DLY Module on/off: 0-63: off 64-127: on
56	0-127	RVB Module on/off: 0-63: off 64-127: on
57	0-127	WAH Module on/off: 0-63: off 64-127: on
58	0-127	TUNER on/off: 0-63: off 64-127: on
59	0-127	LOOPER on/off: 0-63: off 64-127: on
60	0-127	LOOPER Record
61	0-127	LOOPER Auto Record
62	0-127	Looper Play/Stop 0-63: Stop 64-127: Play

## MIDI Control Information List

CC#	Value Range	Description
63	0-127	Looper Tempo 0-63: Half-speed 64-127: Normal Speed
64	0-127	Looper Playback Status 0-63: Reverse 64-127: Normal
65	0-127	Delete Loop
66	0-100	Looper Recording Volume
67	0-100	Looper Playback Volume
68	0-127	Looper Placement 0-63: Rear 64-127: Front
69	0-127	CTRL 1
70	0-127	CTRL 2
71	0-127	CTRL 3
72	0-127	CTRL 4
73	0-1	Tempo MSB, Used with Cc74
74	0-127	CC73=0,CC74=40-127: 40BPM-127BPM CC73=1,CC74=0-122: 128BPM-250BPM
75	0-127	Tap Tempo
92	0-100	Drum Machine Menu on/off: 0-63: off 64-127: on
93	0-127	Drum Machine Play/Stop 0-63: Stop 64-127: Play
94	0-99	Drum Machine Type
95	0-100	Drum Machine Volume

# Troubleshooting

## Device Won't Turn On

- Make sure the power supply is properly connected and the device is switched on.
- Check if the power adapter is working properly.
- Check if you're using the correct power adapter.

## No Sound Or Slight Sound

- Make sure your cables are connected properly.
- Make sure the volume knob (MASTER / PHONES) is adjusted properly.
- When the expression pedal is used for volume control, check its position and volume settings.
- Check the effects module volume settings.
- Check the patch volume settings.
- Make sure your input device is not muted.

## Noise

- Make sure your cables are connected properly.
- Check your instrument output jack.
- Check if you're using the correct power adapter.
- If the noise is coming from your instrument, try using the noise reduction module to reduce it.

## Sound Problems

- Make sure your cables are connected properly.
- Check your instrument output jack.
- If you're using an external expression pedal to control distortion or other similar parameters, check to see if the expression pedal is set up properly.
- Check your effects parameter setup. If effects are set to extremes, GP-200LT may have abnormal noise.

## Problems With Expression Pedal

- Check your expression pedal settings.
- Try calibrating the pedal.

# Technical Specifications

## Technical Specifications

- A/D/A Converter: 24-bit high performance audio
- Sampling Frequency: 44.1 kHz
- SNR: 110dB
- Module: 11, can be used simultaneously
- Patch Memory: 256 Patch slots, 100 Factory Patches
- Looper: Maximum 180 seconds of record time
- Drum Machine: 100 Patterns
- MIDI(IN/OUT/THRU): 1/8" TRS MIDI connectors

## Analog Input Connections

- Guitar Input: 1/4" Unbalanced (TS)
- Input Impedance: 4.7M $\Omega$  (A.GT), 1M $\Omega$  (E.GT), 10k $\Omega$  (Line)
- Return Input: 1/4" Unbalanced (TS)
- Return Input Impedance: 100k $\Omega$
- Aux Input: 1/8" Stereo (TRS)
- Aux Input Impedance: 10k $\Omega$

## Analog Output Connections

- L/R Unbalanced Outputs: 1/4" TS jacks , impedance: 1k $\Omega$
- L/R Balanced Outputs: 1/4" TRS jacks, impedance: 1k $\Omega$
- Send Output: 1/4" Unbalanced (TS) , impedance: 1k $\Omega$
- Headphone Output: 1/8" Stereo (TRS) , impedance: 22 $\Omega$

## Digital Connections

- USB Port: USB 2.0 Type-C Port

## USB Recording Specification

- Sample Rate: 44.1 kHz Bit
- Depth: Supports 16-bit or 24-bit

## Size and weight

- Dimensions: 253mm(W) x 165mm(D) x 56mm(H)
- Unit Weight: 1.25 kg

## Power

- Requirements: DC 9V, 1000mA, center negative